

6

5

4

3

2

1

REVISION

ZONE	REV	DESCRIPTION	DATE	CHANGED BY	APPROVED
	A	INITIAL RELEASE	11/22/2023	DMAY	SPONG

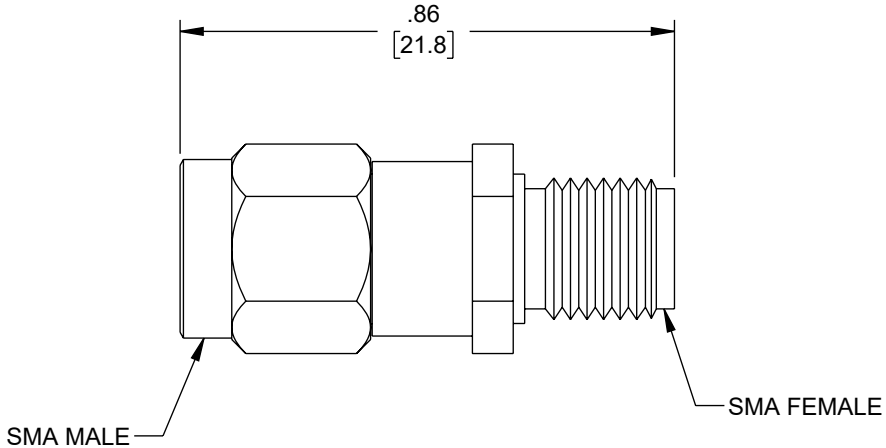
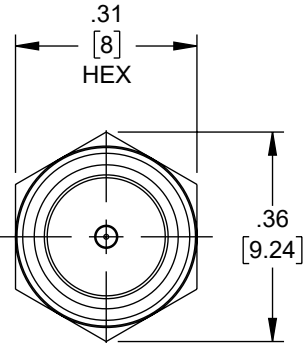

UNLESS OTHERWISE SPECIFIED
LEADING DIMENSIONS ARE INCHES
DIMENSIONS IN [] ARE MILLIMETERS

TOLERANCES:

X = ±.2 [5]	FRACTIONS
.XX = ±.02 [0.5]	± 1/32
.XXX = ±.005 [0.13]	ANGLES ± 1°

CABLE LENGTH TOLERANCES:

≤12 [305]	= +1 [25] / -0
>12 [305] ≤ 60 [1524]	= +2 [51] / -0
>60 [1524] ≤ 120 [3048]	= +4 [102] / -0
>120 [3048] ≤ 300 [7620]	= +6 [152] / -0
>300 [7620]	= +5% / -0

ALL DIMENSIONS ARE FOR REFERENCE ONLY
AND SUBJECT TO CHANGE WITHOUT NOTICE
UN-DIMENSIONED/NON-CRITICAL FEATURES
MAY VARY IN SIZE AND LOCATION
COLORS MAY VARY



Website: www.FairviewMicrowave.com
Phone: 1.800.715.4396 | 1.972.649.6678



INTERPRET ALL DIMENSIONS AND
TOLERANCES PER ASME Y14.5

SCALE	SHEET
NONE	1 OF 1

DESCRIPTION
10dB RF FIXED ATTENUATOR 2W, DC TO 6GHz, SMA MALE TO FEMALE, STAINLESS STEEL

THE INFORMATION CONTAINED IN THIS DRAWING IS THE SOLE PROPERTY OF INFINITE ELECTRONICS, INC. ANY REPRODUCTION IN PART OR WHOLE WITHOUT THE WRITTEN PERMISSION OF INFINITE ELECTRONICS, INC. IS PROHIBITED. THESE COMMODITIES, TECHNOLOGY OR SOFTWARE WERE EXPORTED FROM THE UNITED STATES IN ACCORDANCE WITH THE EXPORT ADMINISTRATION REGULATIONS. DIVERSION CONTRARY TO U.S. LAW PROHIBITED.

SIZE	CAGE CODE	DRAWN BY	ITEM NO.	REV
A	3FKR5	DMAY	FMAT7602-10	A

6

5

4

3

2

1