

LABEL

FAIRVIEW MICROWAVE
IN FMMT6003 OUT
 SN: XXXXXXXXXX

STANDARD TOLERANCES
 .X ±0.2
 .XX ±0.01
 .XXX ±0.005

*STANDARD TOLERANCES APPLY ONLY TO DIMENSIONS IN INCHES

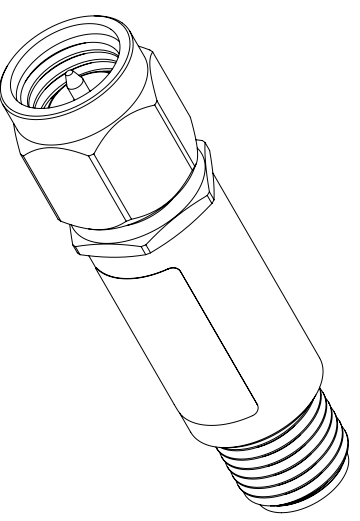

TITLE				
-------	--	--	--	--

NOTES:
 1. UNLESS OTHERWISE SPECIFIED ALL DIMENSIONS ARE NOMINAL.
 2. ALL SPECIFICATIONS ARE SUBJECT TO CHANGE WITHOUT NOTICE AT ANY TIME.
 3. DIMENSIONS ARE IN INCHES [mm].

DWG NO	FMMT6003	CAGE CODE	3FKR5		
CAD FILE	01/14/19	SHEET	1 OF 1	SCALE	N/A
		SIZE	A		7361