

**LABEL**

**FAIRVIEW MICROWAVE**

IN **FMMT6014** OUT

SN: XXXXXXXXXX

**STANDARD TOLERANCES**

.X ±0.2  
 .XX ±0.01  
 .XXX ±0.005

\*STANDARD TOLERANCES APPLY ONLY TO DIMENSIONS IN INCHES

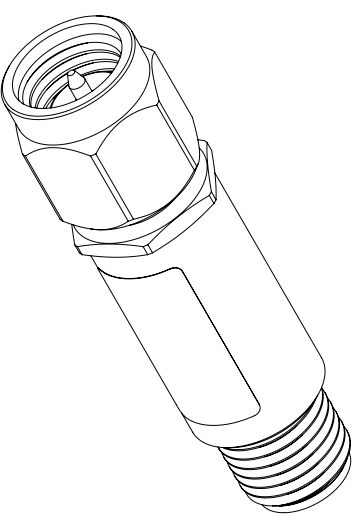

TITLE				
-------	--	--	--	--

NOTES:  
 1. UNLESS OTHERWISE SPECIFIED ALL DIMENSIONS ARE NOMINAL.  
 2. ALL SPECIFICATIONS ARE SUBJECT TO CHANGE WITHOUT NOTICE AT ANY TIME.  
 3. DIMENSIONS ARE IN INCHES [mm].

DWG NO	FMMT6014	CAGE CODE	3FKR5		
CAD FILE	01/14/19	SHEET	1 OF 1	SCALE	N/A
		SIZE	A		7361