

STANDARD TOLERANCES

.X	±0.2
.XX	±0.01
.XXX	±0.005

\*STANDARD TOLERANCES APPLY ONLY TO DIMENSIONS IN INCHES

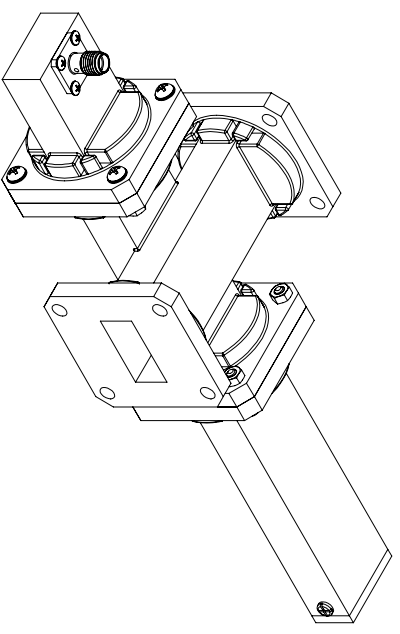

# FAIRVIEW MICROWAVE INC.

ALLEN, TX 75013 WWW.FAIRVIEWMICROWAVE.COM

NOTES:  
 1. UNLESS OTHERWISE SPECIFIED ALL DIMENSIONS ARE NOMINAL.  
 2. ALL SPECIFICATIONS ARE SUBJECT TO CHANGE WITHOUT NOTICE AT ANY TIME.  
 3. DIMENSIONS ARE IN INCHES [mm].

TITLE		DWG NO		CAGE CODE	
		FMWCT1070		3FKR5	
CAD FILE	062717	SHEET	1 OF 1	SCALE	N/A
		SIZE	A		9999