

SMA MALE

SMA FEMALE

LABEL

Fairview Microwave
 RF COMPONENTS ON DEMAND *Done!*
 www.fairviewmicrowave.com
SA18E-12
 YWWW

STANDARD TOLERANCES

- .X ±0.2
- .XX ±0.01
- .XXX ±0.005

*STANDARD TOLERANCES APPLY ONLY TO DIMENSIONS IN INCHES

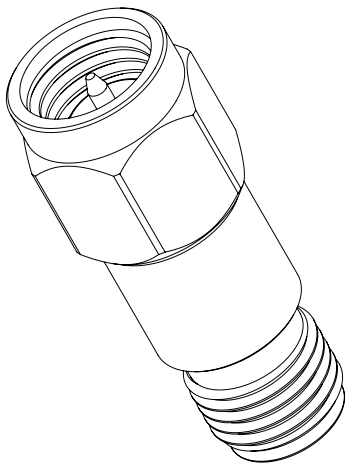

Fairview Microwave
 RF COMPONENTS ON DEMAND. *Done!*

NOTES:
 1. UNLESS OTHERWISE SPECIFIED ALL DIMENSIONS ARE NOMINAL.
 2. ALL SPECIFICATIONS ARE SUBJECT TO CHANGE WITHOUT NOTICE AT ANY TIME.
 3. DIMENSIONS ARE IN INCHES [mm].

TITLE		DWG NO		CAGE CODE	
		SA18E-12		3FKR5	
CAD FILE	12/18/18	SHEET	1 OF 1	SCALE	N/A
				SIZE	A
					7361