

SMA MALE

SMA FEMALE

LABEL



STANDARD TOLERANCES

.X ±0.2
.XX ±0.01
.XXX ±0.005

*STANDARD TOLERANCES APPLY ONLY TO DIMENSIONS IN INCHES

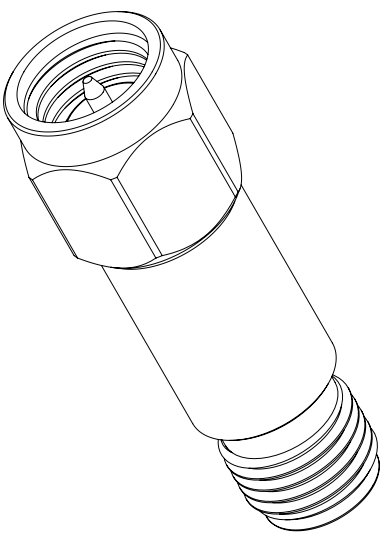

NOTES:
1. UNLESS OTHERWISE SPECIFIED ALL DIMENSIONS ARE NOMINAL.
2. ALL SPECIFICATIONS ARE SUBJECT TO CHANGE WITHOUT NOTICE AT ANY TIME.
3. DIMENSIONS ARE IN INCHES [mm].

TITLE		DWG NO		CAGE CODE	
		SA18E-15		3FKR5	
CAD FILE	12/18/18	SHEET	1 OF 1	SCALE	N/A
				SIZE	A
					7361