

29 dB Gain GaN Input Protected Low Noise Amplifier Operating from 1 GHz to 23 GHz with 3.5 dB NF, 23 dBm Psat and SMA

The FMAM1074 is an Input Protected broadband Low Noise Amplifier that operates from 1 GHz to 23 GHz. The module utilizes Gallium Nitride (GaN) and chip-and-wire technology in the manufacturing process that ensures state-of-the-art input power handling performance for overdrive protection. The 50 ohm design has 2.5 dB typical noise figure with RF input power handling capability up to 10 watts. Additional typical performance includes 29 dB small signal gain, 1.8:1 VSWR, output P1dB of +20 dBm, output Psat of +23 dBm, and output IP3 of +27 dBm. Operational temperature range is -45°C to +85°C and the bias voltage requirement is +24Vdc with 250 mA of DC current. The rugged Mil Grade aluminum package has an epoxy sealed cover and supports SMA female connectors. The model is designed to meet a series of environmental conditions including Altitude, Vibration, Humidity, and Shock.

Electrical Specifications (TA = +25°C , DC Voltage = +24Vdc , DC Current = 250mA)

Description	Min	Typ	Max	Unit
Frequency Range	1		23	GHz
Small Signal Gain	27	29	31	dB
Gain Flatness		±1.5	±2	dB
Gain Variance at OTR*		1.25		dB
Output at 1 dB Compression Point		+20		dBm
Saturated Output Power (Psat)		+23		dBm
Output 3rd Intercept Point		+32		dBm
Noise Figure		3.5	8	dB
Input VSWR		1.8:1		
Output VSWR		1.8:1		
Reverse Isolation		-55		dB
Input Power (CW)			+40	dBm
Operating DC Voltage		+24	+28	Volts
Operating DC Current		250	360	mA
Operating Temperature Range	-45		+85	°C

*OTR= Base Plate Operating Temperature Range

RF Characteristic

Description	F1	F2	F3	Units
Frequency Range	1 to 12	12 to 23		GHz
Small Signal Gain	31	27		dB
Output at P1dB	26	20		dBm
Output 3rd Intercept Point	36	27		dBm
Noise Figure	3.5	5		dB



Features:

- Input Protected Broadband Low Noise Amplifier
- GaN Semiconductor Technology
- Frequency Range 1 GHz to 23 GHz
- RF Power Handling 10 Watts
- Noise Figure 2.5 dB
- Small Signal Gain 29 dB
- VSWR 1.8:1
- Output P1dB +20 dBm
- Output Psat +23 dBm
- Output IP3 +32 dBm
- Isolation -55 dB
- DC Voltage +24 Vdc
- DC Current 250 mA
- 50 Ohm Design
- SMA Female Connectors
- Rugged Mil Grade Aluminum Package Design
- -45°C to +85°C Operating Temperature

Applications:

- Aerospace & Defense
- Microwave Radio
- Military & Commercial Communication
- VSAT
- SATCOM
- Test & Measurement
- Wireless Infrastructure
- Fiber Optics

Fairview Microwave
 301 Leora Ln., Suite 100
 Lewisville, TX 75056
 Tel: 1-800-715-4396 / (972) 649-6678
 Fax: (972) 649-6689
www.fairviewmicrowave.com
sales@fairviewmicrowave.com

Electrical Procedures
Biasing Up Procedure

Step 1	Connect Ground Pin
Step 2	Connect Input and Output
Step 3	Connect +24 V Biasing

Power OFF Procedure

Step 1	Turn off +24 V Biasing
Step 2	Remove RF Connection
Step 3	Remove Ground

Absolute Maximum Rating

Parameter	Rating	Units
Operating Voltage	+28	Volts
RF Input Power @(50 Ω)	+40	dBm



ESD Sensitive Material,
 Transport material in
 Approved ESD bags.
 Handle only in approved
 ESD Workstation.

Mechanical Specifications
Size

Length	2.6 in [66.04 mm]
Width	1.18 in [29.97 mm]
Height	0.47 in [11.94 mm]
Weight	0.6 lbs [272.16 g]

Input Connector	SMA Female
Output Connector	SMA Female

Environmental Specifications
Temperature

Operating Range	-45 to +85 deg C
Storage Range	-55 to +125 deg C

Humidity	100% RH at 35°C, 95% RH at 40°C
Shock	20G for 11 ms half sine wave, 3 axis both directions
Vibration	25g RMS (15 degrees 2KHz) endurance, 1 hour per axis
Altitude	30,000 ft. (Epoxy Sealed Controlled Environment)

Compliance Certifications (see [product page](#) for current document)

Plotted and Other Data

Notes:

- Values at 25 °C, sea level

Amplifier Power-up Precautions

- 1.) Confirm that proper ESD precautions and controls are always in place before handling any Amplifier module.
- 2.) Confirm adequate thermal management is in place to effectively dissipate heat away from the Amplifier package. The Amplifier operational baseplate temperature must be within the operational temperature range stated in the Amplifier datasheet. Depending on the design and thermal requirements, using a heatsink with cooling fan is always recommended for safe reliable operation. A heat sink without a cooling fan may also be used. Damage caused from overheating will void the warranty.
- 3.) Confirm adequate system grounding is established. The DC power supply and Amplifier must have a common ground in order to operate properly.
- 4.) Power Amplifiers may require additional DC Current when initially powered-up. Depending on the design, the input current draw could range from an additional 10% to 100% above the maximum rated DC current of the Amplifier. This varies based on product part number.
- 5.) Confirm the DC power supply, if limited, is set to allow for additional start-up current that's rated for the Power Amplifier.
- 6.) Confirm the system is designed and calibrated for 50 ohms. Any impedance mismatch may cause performance issues.
- 7.) Perform a CALIBRATION (if required) with the loads before connecting the Amplifier to the Network Analyzer to ensure proper performance.
- 8.) Use a fixed attenuator between the signal source and input port of the Amplifier to optimize the input VSWR match.
- 9.) Confirm the input power level at the input port of the amplifier does not exceed the maximum rated limit for input power (as stated in the Amplifier datasheet).
 - P_{in} for Small Signal Gain = P1dB-SSG-10 dB
 - P_{in} for P1dB = P1dB-SSG+1 dB
- 10.) Confirm the Network Analyzer is always connected to the Amplifier first before DC power is applied to the Amplifier.
- 11.) As long as the input and output ports of the amplifier are connected to a 50Ohm load and RF signal power is applied, the Amplifier can be powered up with DC voltage.
- 12.) Confirm the Amplifier output load is matched for a 50 Ohm impedance and will not exceed the maximum rated VSWR or Return Loss limit for the Amplifier. Exceeding the maximum rated VSWR or Return Loss limit will result in reflected signal power that could damage the Amplifier and void the warranty.
- 13.) **Power Amplifier connected to an Antenna for signal transmission** - It's strongly recommended to use a high power fixed attenuator pad or an Isolator between the output port of the Amplifier and input port to the antenna. Any reflected signal power due to impedance mismatch will likely damage the Amplifier and void the warranty.
- 14.) The attenuator or isolator used at the output port of the Amplifier must be rated to handle the output power level and operational frequency band of the amplifier.

Typical Performance Data

Gain @+25°C

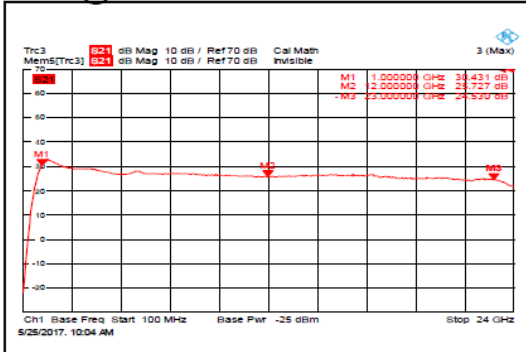

Input VSWR @+25°C

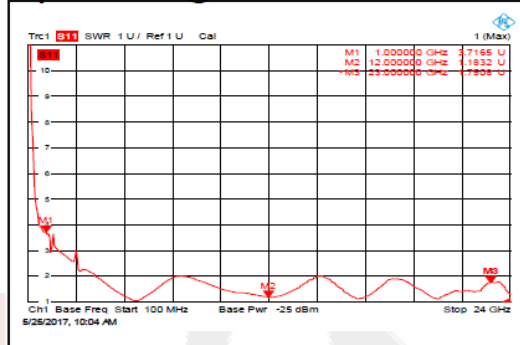

Output VSWR @+25°C

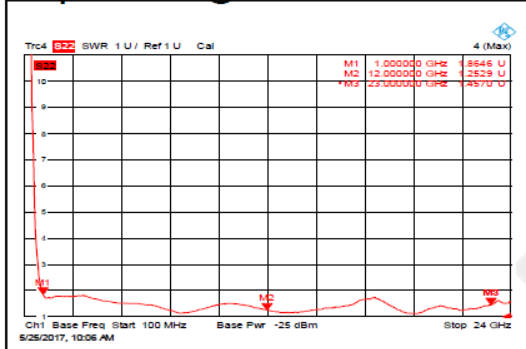

Isolation @+25°C

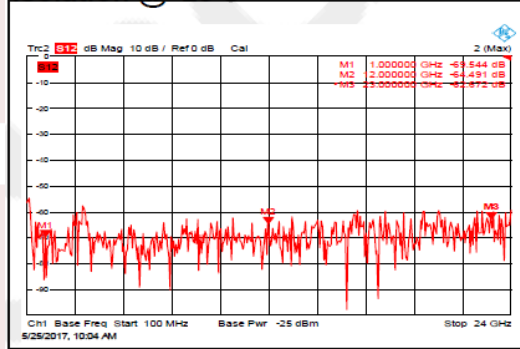

Gain @-45°C

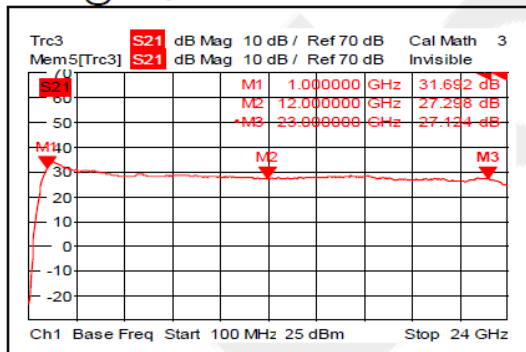

Input VSWR @-45°C

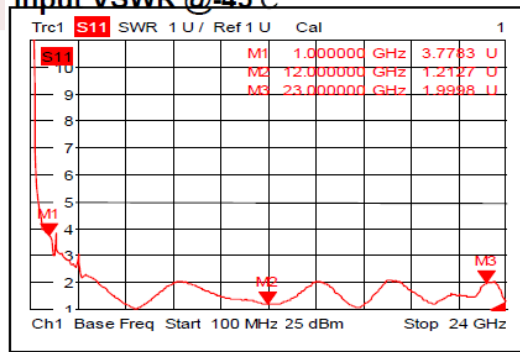

Output VSWR @-45°C

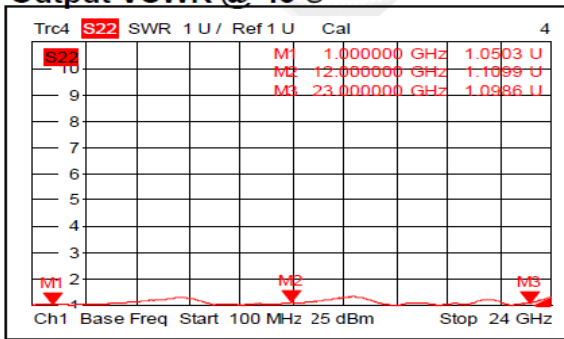

Isolation @-45°C

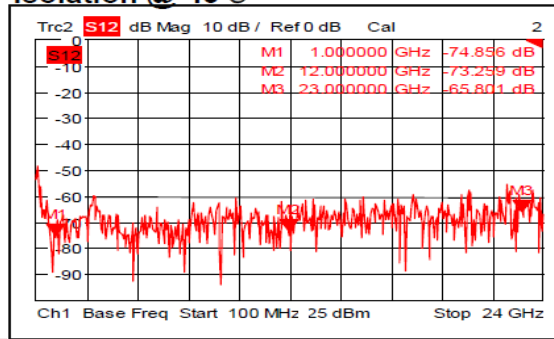

Gain @+85°C

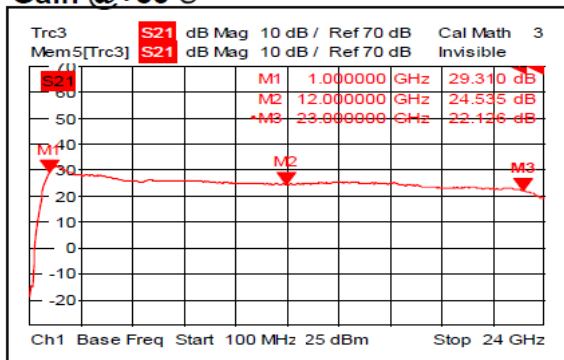

Input VSWR @+85°C

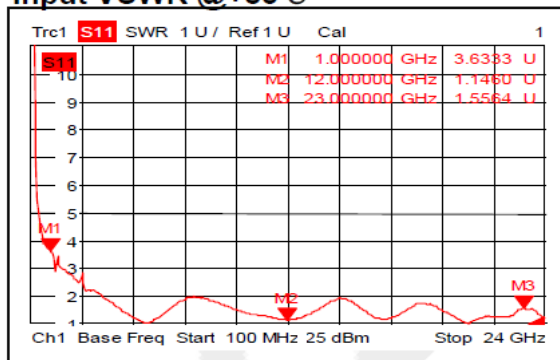

Output VSWR @+85°C

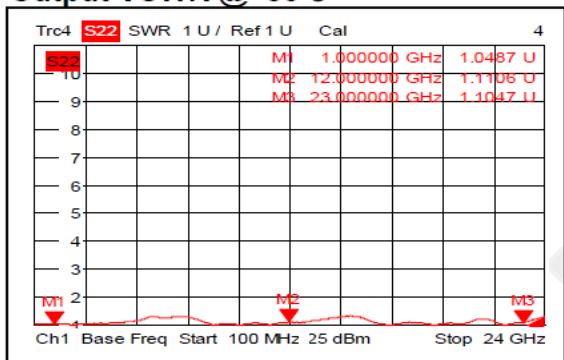

Isolation @+85°C

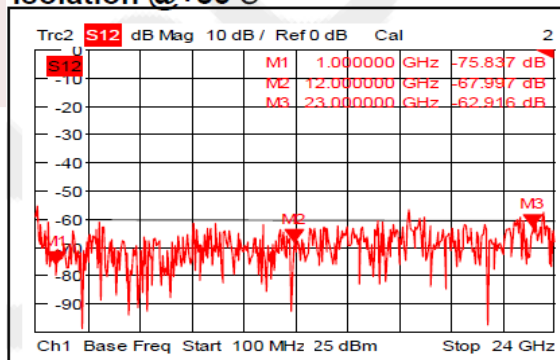

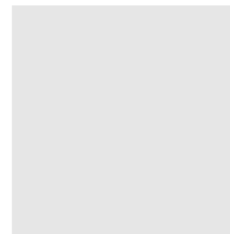
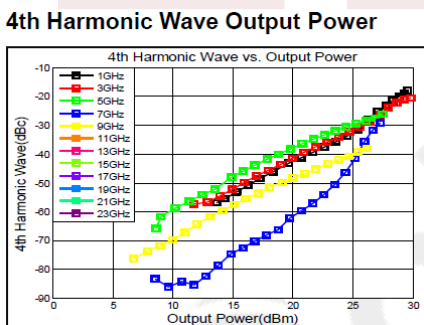
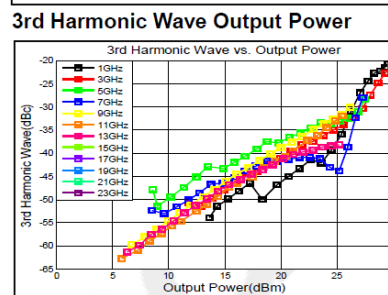
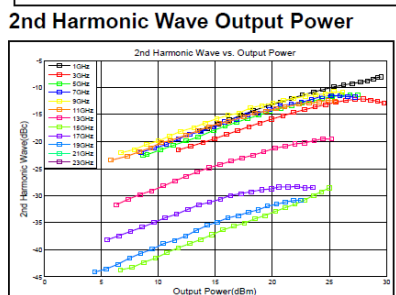
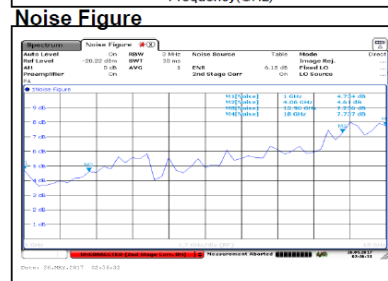
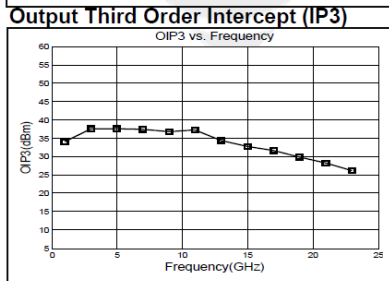
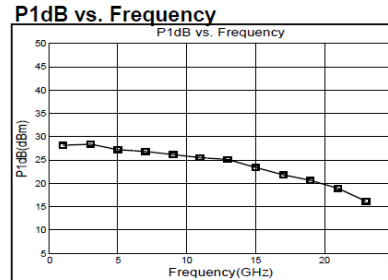
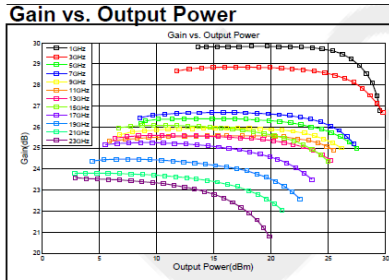

29 dB Gain GaN Input Protected Low Noise Amplifier Operating from 1 GHz to 23 GHz with 3.5 dB NF, 23 dBm Psat and SMA from Fairview Microwave is in-stock and available to ship same-day. All of our RF/microwave products are available off-the-shelf from our ISO 9001:2008 certified facilities in Lewisville, Texas. Fairview Microwave is RF on-demand.

For additional information on this product, please click the following link: [29 dB Gain GaN Input Protected Low Noise Amplifier Operating from 1 GHz to 23 GHz with 3.5 dB NF, 23 dBm Psat and SMA FMAM1074](https://www.fairviewmicrowave.com/3.5db-nf-low-noise-amplifier-29db-fmam1074-p.aspx)

URL: <https://www.fairviewmicrowave.com/3.5db-nf-low-noise-amplifier-29db-fmam1074-p.aspx>

The information contained in this document is accurate to the best of our knowledge and representative of the part described herein. It may be necessary to make modifications to the part and/or the documentation of the part, in order to implement improvements. Fairview Microwave reserves the right to make such changes as required. Unless otherwise stated, all specifications are nominal. Fairview Microwave does not make any representation or warranty regarding the suitability of the part described herein for any particular purpose, and Fairview Microwave does not assume any liability arising out of the use of any part or documentation.

REVISIONS			
REV.	DESCRIPTION	DATE	APPROVED
A	INITIAL RELEASE	9/11/2020	T.GALLA

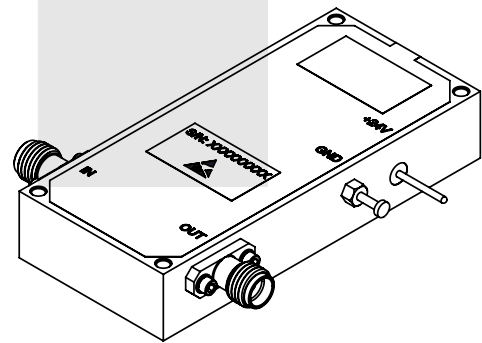
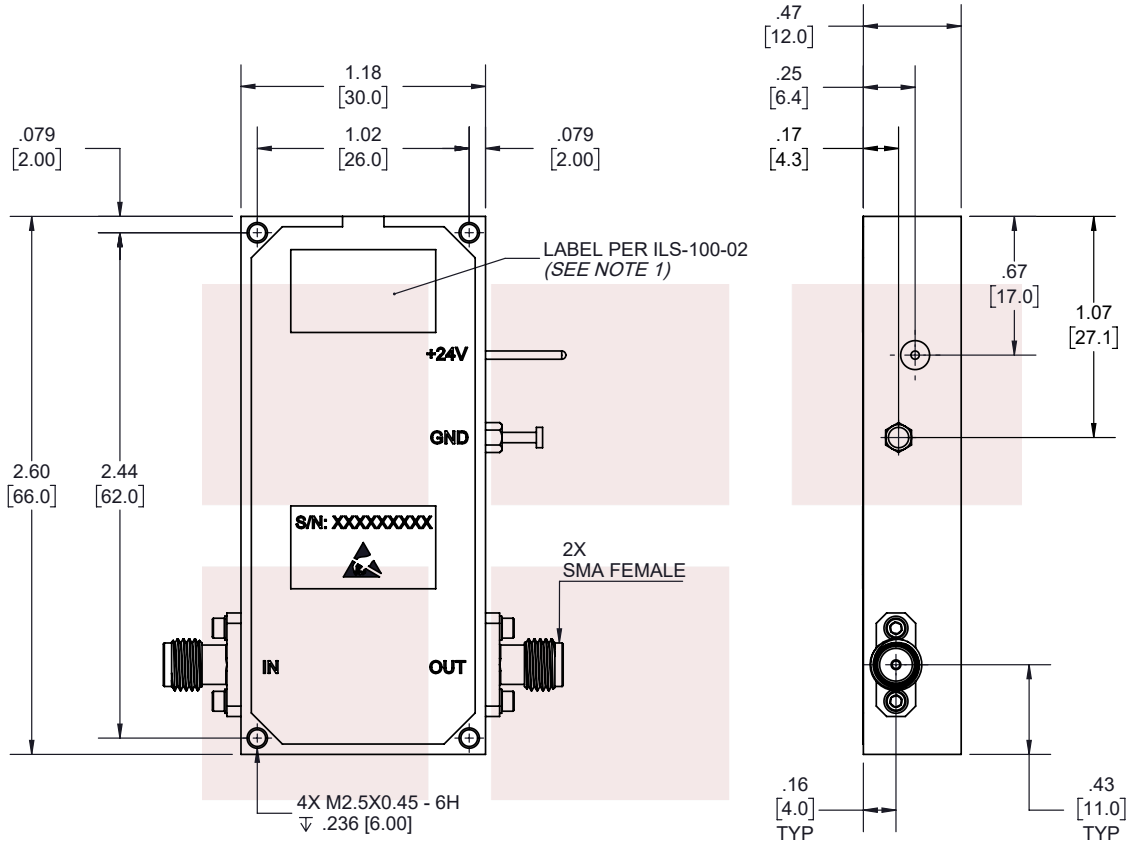

- NOTES:
1. LABEL PER ILS-100-02. FOR INTERNAL REFERENCE ONLY. LABEL LOCATION FOR REFERENCE ONLY.

THESE COMMODITIES, TECHNOLOGY OR SOFTWARE WERE EXPORTED FROM THE UNITED STATES IN ACCORDANCE WITH THE EXPORT ADMINISTRATION REGULATIONS. DIVERSION CONTRARY TO U.S. LAW PROHIBITED.

TITLE
29 dB Gain GaN Input Protected Low Noise Amplifier
Operating from 1 GHz to 23 GHz with 3.5 dB NF, 23 dBm Psat and SMA

UNLESS OTHERWISE SPECIFIED LEADING DIMENSIONS ARE INCHES
DIMENSIONS IN [] ARE MILLIMETERS

TOLERANCES: CABLE LENGTH (L) TOLERANCES:

.X = ±.2 [5.08]	FRACTIONS	L ≤ 12 [305] = +1 [25] / -0
.XX = ±.02 [.51]	± 1/32	12 [305] < L ≤ 60 [1524] = +2 [51] / -0
.XXX = ±.005 [.13]	ANGLES ± 1°	60 [1524] < L ≤ 120 [3048] = +4 [102] / -0
		120 [3048] < L ≤ 300 [7620] = +6 [152] / -0
		300 [7620] < L = +5%L / -0

THIRD-ANGLE PROJECTION

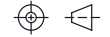

THE INFORMATION AND DESIGN IN THIS DOCUMENT IS THE PROPERTY OF FAIRVIEW MICROWAVE CORPORATION. ALL RIGHTS RESERVED.

SHEET 1 OF 1

SCALE N/A

ALL DIMENSIONS SHOWN ARE FOR REFERENCE ONLY.

SIZE A	CAGE CODE 3FKR5	DRAWN BY K.DANG	ITEM NO. FMAM1074	REV A
-----------	--------------------	--------------------	----------------------	----------

T-Rev.D