

Medium Power Amplifier with Heatsink at 1 Watt P1dB  
Operating from 500 MHz to 4 GHz with SMA

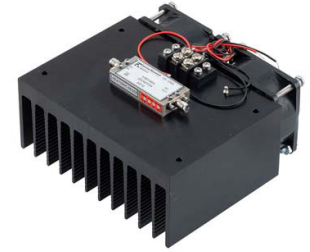

**FMAM4053F**

**Features**

- 0.5 to 4 GHz Frequency Range
- P1dB 1 Watt min.
- Small Signal Gain: 30 dB min.
- Gain Flatness:  $\pm 3$  dB max.
- Noise Figure 6 dB max.
- 50 Ohm Input and Output Matched
- 0 to 50°C Operating Temperature
- Unconditionally Stable
- Single DC Positive Supply
- Built-in DC Voltage Regulator
- Field Replaceable SMA Female connectors
- Meets MIL-STD-202 Test Conditions
- Integrated Finned Heatsink with Cooling Fan

**Applications**

- Electronic Warfare
- Electronic Countermeasures
- Radar Systems
- Telecom Infrastructure
- Test Instrumentation
- Communication Systems
- Satellite Communications
- Microwave Radio Systems
- Driver Amplifier
- High Power Output Amplifier

**Description**

The FMAM4053F is a coaxial medium power amplifier with finned heatsink and cooling fan, operating in the 0.5 to 4 GHz frequency range. The amplifier offers 1 Watt of P1dB minimum and 30 dB small signal gain minimum, with gain flatness of  $\pm 3$  dB max. This power amplifier heatsink assembly requires 2 separate DC voltage supplies. The Amplifier module requires +12 Vdc and the heatsink block requires +12 Vdc. Voltage connections are made at the terminal block on the topside of the heatsink, which connects the Amplifier and Heatsink fan voltages. Operational temperature range is 0°C to 50°C. The integrated design comes fully assembled and effectively maintains an adequate baseplate temperature for highly reliable operation. Additionally, the amplifier module supports field replaceable connectors and is designed to meet MIL-STD-202 environmental test conditions for Humidity, Shock, Vibration, and Altitude.

**Electrical Specifications** (TA = +25°C, DC Voltage = +12Volts, DC Current = 1.5A)

Description	Min	Typ	Max	Unit
Frequency Range	0.5		4	GHz
Small Signal Gain	30			dB
Gain Flatness			$\pm 3$	dB
Output Power at 1 dB Compression Point	+30			dBm
Noise Figure 1			6	dB
Impedance (Input)		50		Ohms
Impedance (Output)		50		Ohms
Input VSWR			2.5:1	
Output VSWR			2.5:1	
Operating DC Voltage		+12		Volts
Operating DC Current		1.5		A
Operating Temperature Range	0		+50	°C
Heatsink Fan Voltage		12		Vdc
Heatsink Fan Current		1.16		A

Medium Power Amplifier with Heatsink at 1 Watt P1dB  
Operating from 500 MHz to 4 GHz with SMA

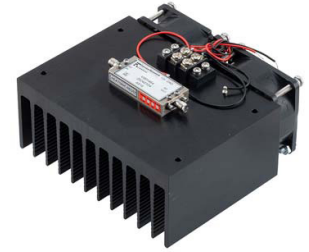

## FMAM4053F

### Mechanical Specifications

#### Size

Length	5.51 in [139.95 mm]
Width	4 in [101.6 mm]
Height	2.28 in [57.91 mm]
Weight	3 lbs [1.36 kg]
Input Connector	SMA Female
Output Connector	SMA Female
Bias Connector	Solder Pin
Heatsink Fin Material	6063-T5 Aluminum Alloy Black Anodyne finish

### Environmental Specifications

#### Temperature

Operating Range	0 to +50 deg C
Storage Range	-40 to +100 deg C
Humidity	MIL-STD-202F, Method 103B, Condition B
Shock	MIL-STD-202F, Method 213B, Condition B
Vibration	MIL-STD-202F, Method 204D, Condition B
Altitude	MIL-STD-202F, Method 105C, Condition B

**Compliance Certifications** (see [product page](#) for current document)

### Plotted and Other Data

Notes:

- Values at 25 °C, sea level
- Heatsink Included

## Medium Power Amplifier with Heatsink at 1 Watt P1dB Operating from 500 MHz to 4 GHz with SMA

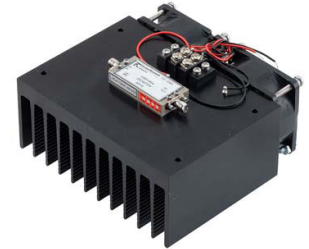

### FMAM4053F

#### Amplifier Power-up Precautions

- 1.) Confirm that proper ESD precautions and controls are always in place before handling any Amplifier module.
- 2.) Confirm adequate thermal management is in place to effectively dissipate heat away from the Amplifier package. The Amplifier operational baseplate temperature must be within the operational temperature range stated in the Amplifier datasheet. Depending on the design and thermal requirements, using a heatsink with cooling fan is always recommended for safe reliable operation. A heat sink without a cooling fan may also be used. Damage caused from overheating will void the warranty.
- 3.) Confirm adequate system grounding is established. The DC power supply and Amplifier must have a common ground in order to operate properly.
- 4.) Power Amplifiers may require additional DC Current when initially powered-up. Depending on the design, the input current draw could range from an additional 10% to 100% above the maximum rated DC current of the Amplifier. This varies based on product part number.
- 5.) Confirm the DC power supply, if limited, is set to allow for additional start-up current that's rated for the Power Amplifier.
- 6.) Confirm the system is designed and calibrated for 50 ohms. Any impedance mismatch may cause performance issues.
- 7.) Perform a CALIBRATION (if required) with the loads before connecting the Amplifier to the Network Analyzer to ensure proper performance.
- 8.) Use a fixed attenuator between the signal source and input port of the Amplifier to optimize the input VSWR match.
- 9.) Confirm the input power level at the input port of the amplifier does not exceed the maximum rated limit for input power (as stated in the Amplifier datasheet).
  - $P_{in}$  for Small Signal Gain = P1dB-SSG-10 dB
  - $P_{in}$  for P1dB = P1dB-SSG+1 dB
- 10.) Confirm the Network Analyzer is always connected to the Amplifier first before DC power is applied to the Amplifier.
- 11.) As long as the input and output ports of the amplifier are connected to a 50Ohm load and RF signal power is applied, the Amplifier can be powered up with DC voltage.
- 12.) Confirm the Amplifier output load is matched for a 50 Ohm impedance and will not exceed the maximum rated VSWR or Return Loss limit for the Amplifier. Exceeding the maximum rated VSWR or Return Loss limit will result in reflected signal power that could damage the Amplifier and void the warranty.
- 13.) **Power Amplifier connected to an Antenna for signal transmission** - It's strongly recommended to use a high power fixed attenuator pad or an Isolator between the output port of the Amplifier and input port to the antenna. Any reflected signal power due to impedance mismatch will likely damage the Amplifier and void the warranty.
- 14.) The attenuator or isolator used at the output port of the Amplifier must be rated to handle the output power level and operational frequency band of the amplifier.

Medium Power Amplifier with Heatsink at 1 Watt P1dB  
Operating from 500 MHz to 4 GHz with SMA

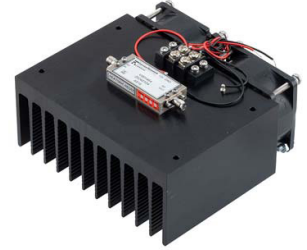

**FMAM4053F**

**Typical Performance Data**

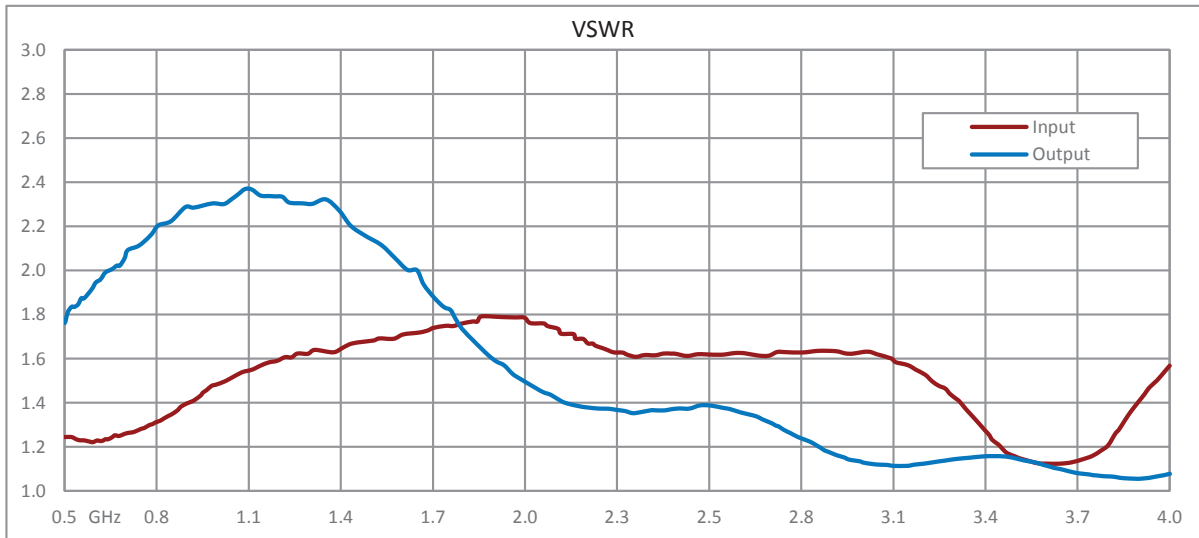
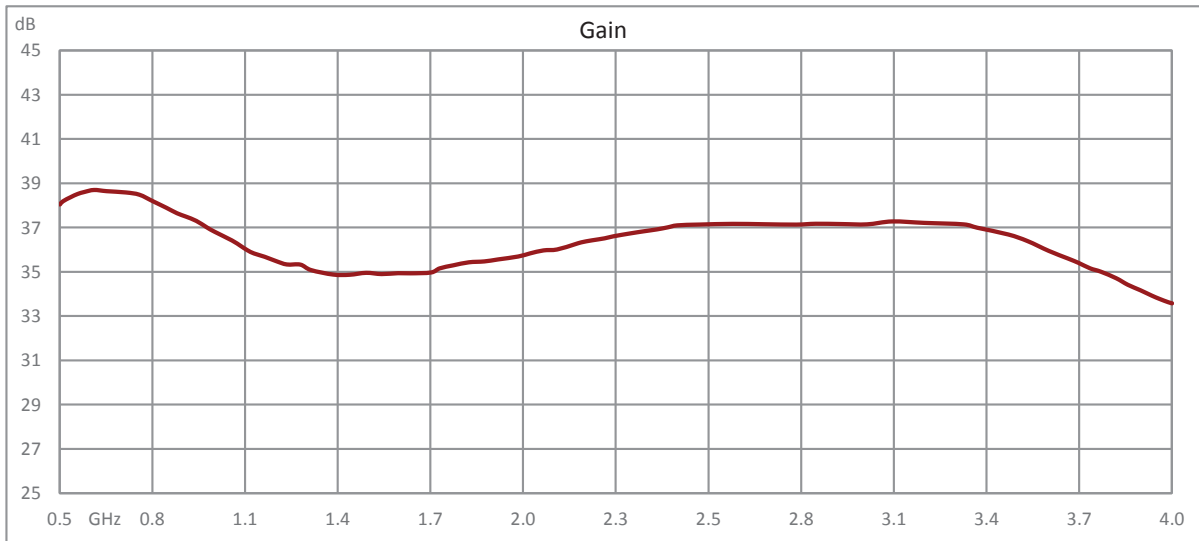

Medium Power Amplifier with Heatsink at 1 Watt P1dB  
Operating from 500 MHz to 4 GHz with SMA

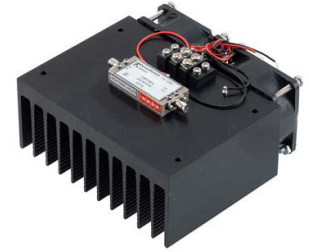

**FMAM4053F**

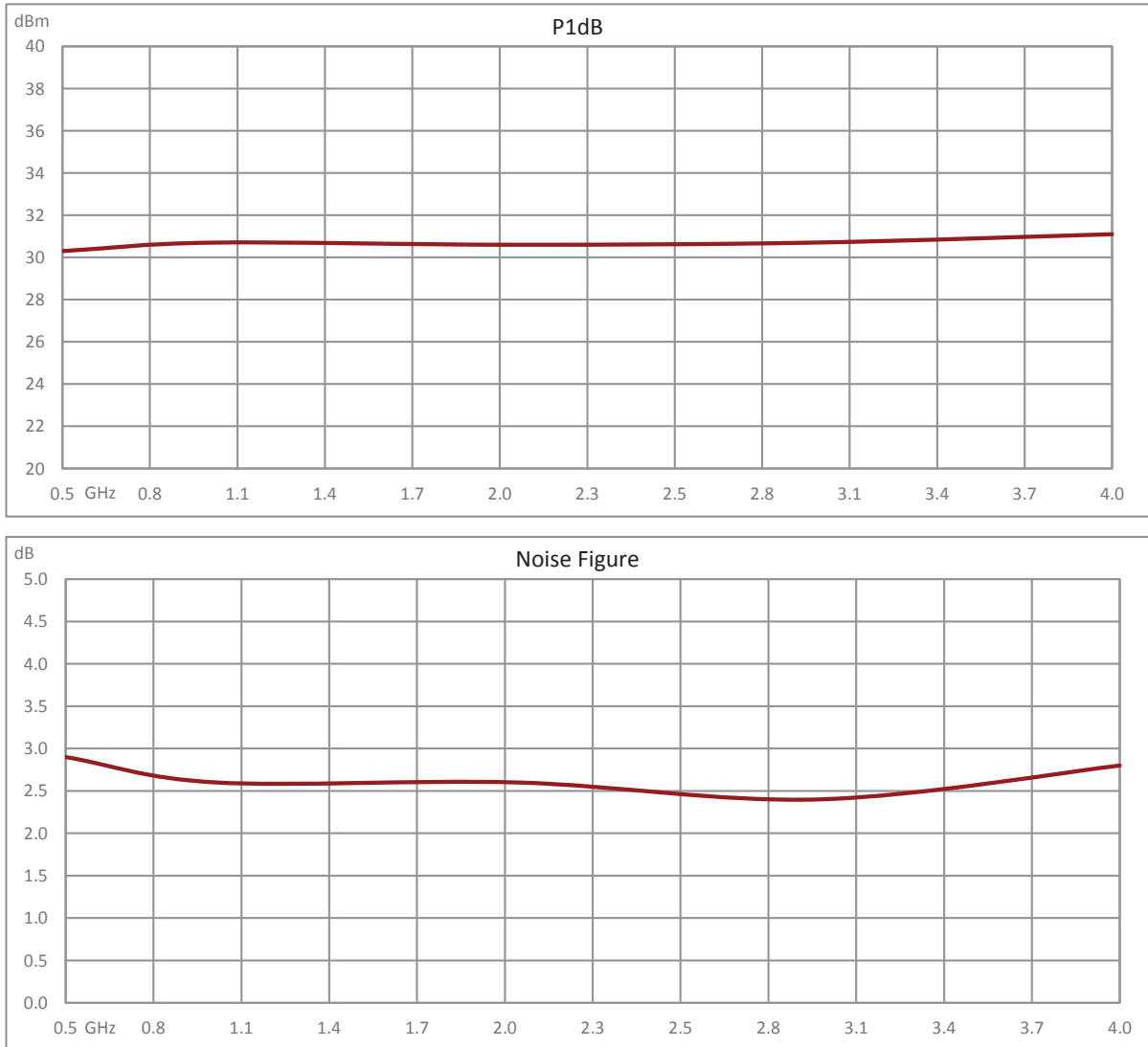

## Medium Power Amplifier with Heatsink at 1 Watt P1dB Operating from 500 MHz to 4 GHz with SMA

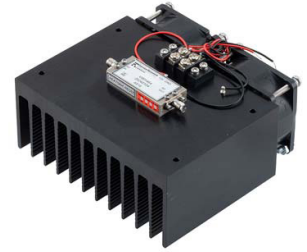

### FMAM4053F

---

Medium Power Amplifier with Heatsink at 1 Watt P1dB Operating from 500 MHz to 4 GHz with SMA from Fairview Microwave is in-stock and available to ship same-day. All of our RF/microwave products are available off-the-shelf from our ISO 9001:2008 certified facilities in Lewisville, Texas. Fairview Microwave is RF on-demand.

For additional information on this product, please click the following link: [Medium Power Amplifier with Heatsink at 1 Watt P1dB Operating from 500 MHz to 4 GHz with SMA FMAM4053F](https://www.fairviewmicrowave.com/medium-power-amplifier-1watt-30db-fmam4053f-p.aspx)

URL: <https://www.fairviewmicrowave.com/medium-power-amplifier-1watt-30db-fmam4053f-p.aspx>

The information contained within this document is accurate to the best of our knowledge and representative of the part described herein. It may be necessary to make modifications to the part and/or the documentation of the part in order to implement improvements. Fairview Microwave reserves the right to make such changes as required. Unless otherwise stated, all specifications are nominal. Fairview Microwave does not make any representation or warranty regarding the suitability of the part described herein for any particular purpose, and Fairview Microwave does not assume liability arising out of the use of any part or document.

# FMAM4053F CAD Drawing

Medium Power Amplifier with Heatsink at 1 Watt P1dB Operating from 500 MHz to 4 GHz with SMA

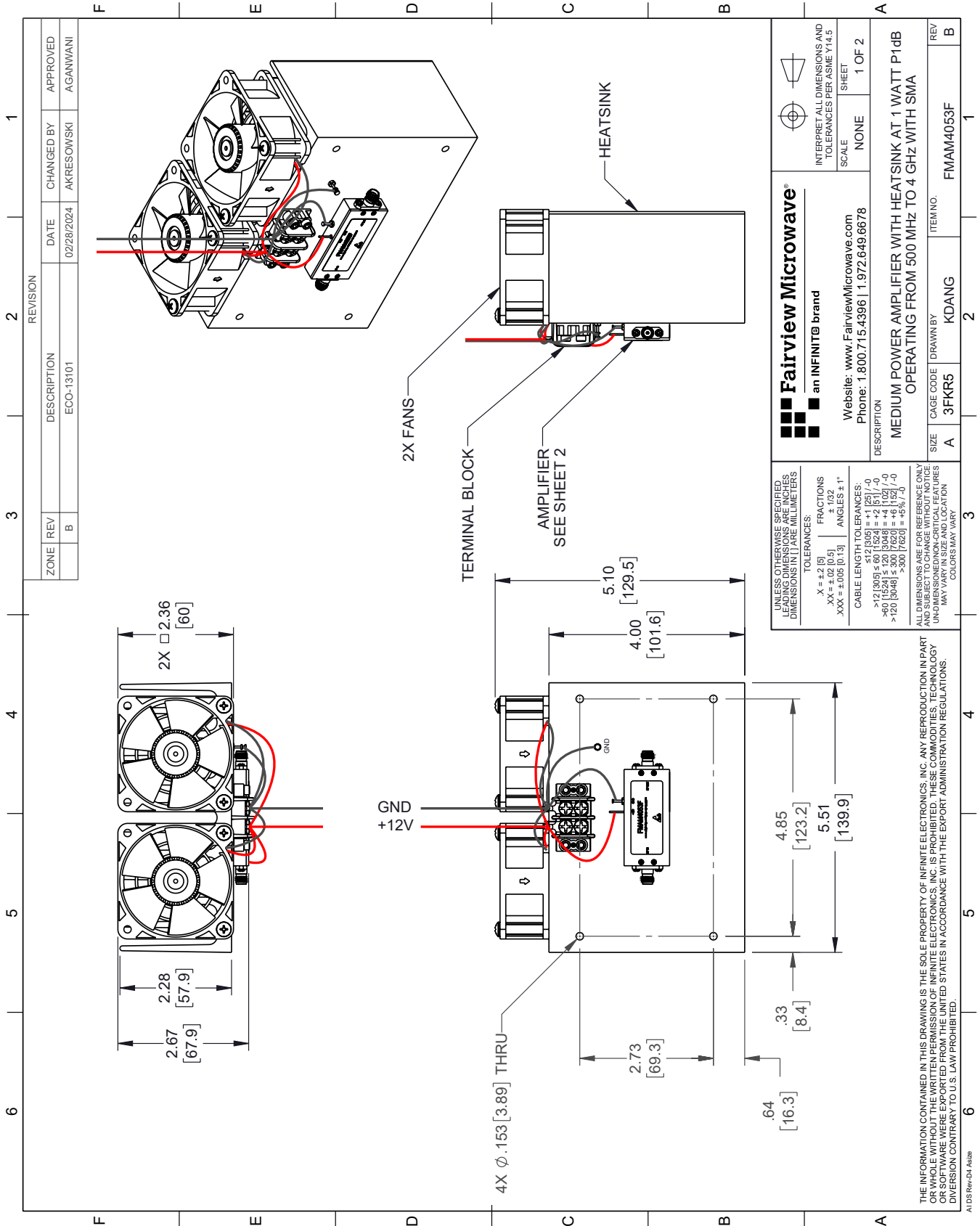

# FMAM4053F CAD Drawing

Medium Power Amplifier with Heatsink at 1 Watt P1dB Operating from 500 MHz to 4 GHz with SMA

## AMPLIFIER DETAIL

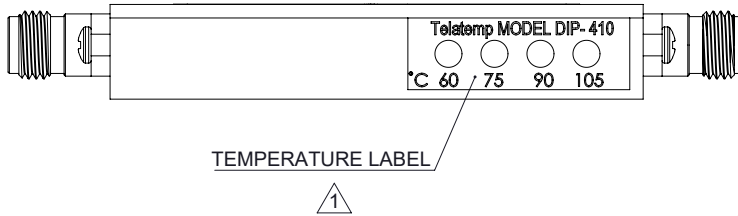
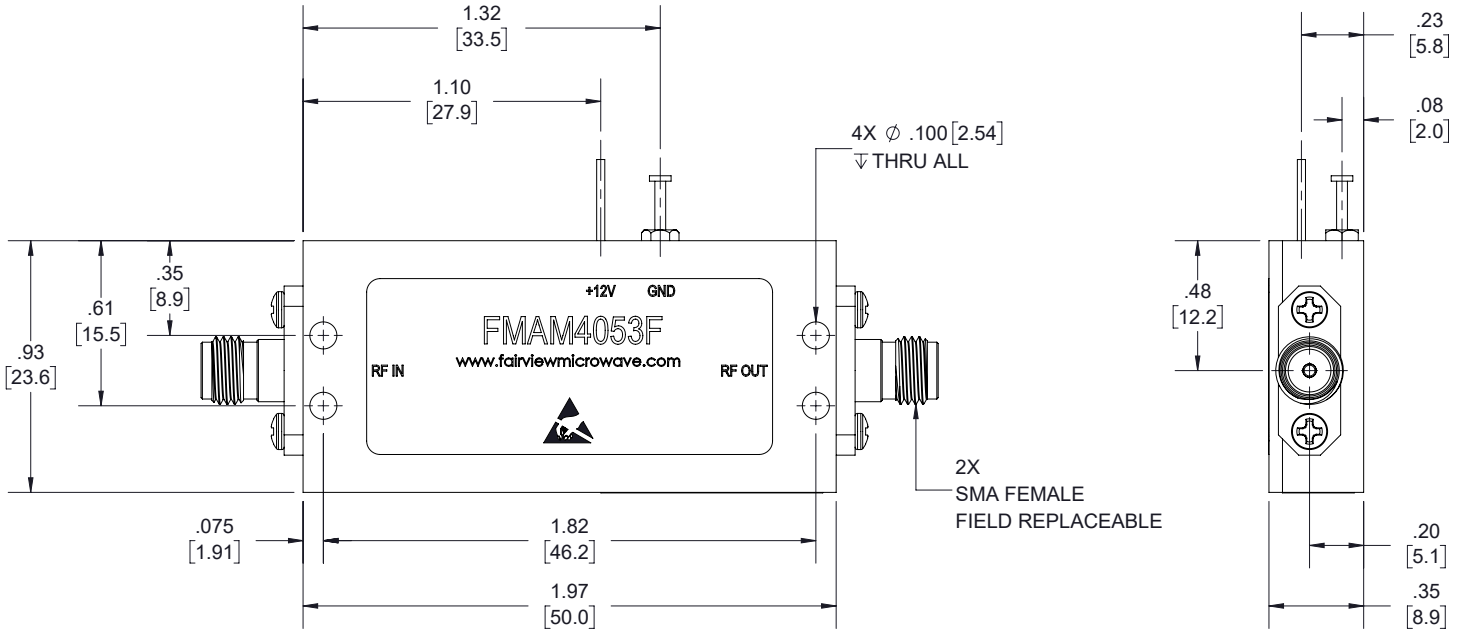

### NOTE:

1. WARRANTY VOID IF REMOVED.

#### STANDARD TOLERANCES

.X ±0.2  
.XX ±0.01  
.XXX ±0.005

\*STANDARD TOLERANCES APPLY ONLY TO DIMENSIONS IN INCHES

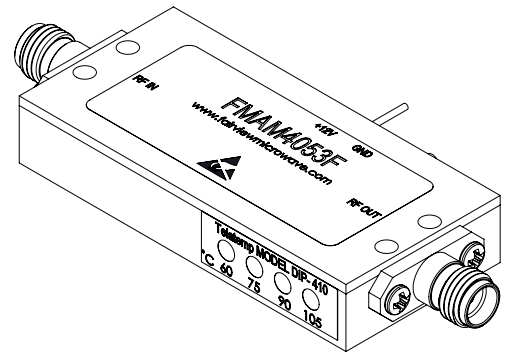

 <b>Fairview Microwave</b> an INFINIT <sup>®</sup> brand	NOTES: 1. UNLESS OTHERWISE SPECIFIED ALL DIMENSIONS ARE NOMINAL. 2. ALL SPECIFICATIONS ARE SUBJECT TO CHANGE WITHOUT NOTICE AT ANY TIME. 3. DIMENSIONS ARE IN INCHES [mm].	
	DWG NO <b>FMAM4053F</b>	CAGE CODE <b>3FKR5</b>
TITLE	CAD FILE 09/23/19 SHEET 2 OF 2	SCALE N/A SIZE A 7361