

## Medium Power GaAs Amplifier at 1.5 Watt Psat Operating from 800 MHz to 4.2 GHz with 41 dBm IP3, SMA w/ Heatsink and Fan

FMAM5034F is a 1.5 W high gain coaxial power amplifier operating in the 0.8 to 4.2 GHz frequency range. The amplifier offers 1.5 Watts minimum of saturated power and 31 dB typical small signal gain with  $\pm 2.0$  dB maximum gain flatness. The amplifier requires typically a +13V DC power supply. The connectorized SMA module is unconditionally stable, operates over the temperature range of 0°C and +50°C, and has a heatsink and fan for proper operation.

### Electrical Specifications

(TA = +25°C)

| Description                      | Min   | Typ   | Max     | Unit  |
|----------------------------------|-------|-------|---------|-------|
| Frequency Range                  | 0.8   |       | 4.2     | GHz   |
| Small Signal Gain                | 31    |       |         | dB    |
| Gain Flatness                    |       |       | $\pm 2$ | dB    |
| Input Power (CW)                 |       |       | +10     | dBm   |
| Psat                             |       | +31.8 |         | dBm   |
| P1dB                             | +30.8 |       |         | dBm   |
| Output 3rd Order Intercept Point |       | +41   |         | dBm   |
| Harmonics                        |       | -20   |         | dBc   |
| Spurious                         |       | -60   |         | dBc   |
| Impedance (Input)                |       | 50    |         | Ohms  |
| Impedance (Output)               |       | 50    |         | Ohms  |
| Input VSWR                       |       |       | 2.2:1   |       |
| Operating DC Voltage             |       | +13   |         | Volts |
| Operating DC Current             |       |       | 1       | A     |
| Operating Temperature Range      | 0     |       | +50     | °C    |

### Mechanical Specifications

|                  |                      |
|------------------|----------------------|
| <b>Size</b>      |                      |
| Length           | 3.94 in [100.08 mm]  |
| Width            | 2.9 in [73.66 mm]    |
| Height           | 2.1 in [53.34 mm]    |
| Weight           | 0.924 lbs [419.12 g] |
| Input Connector  | SMA Female           |
| Output Connector | SMA Female           |

### Environmental Specifications

|                    |                        |
|--------------------|------------------------|
| <b>Temperature</b> |                        |
| Operating Range    | 0 to +50 deg C         |
| Humidity           | 95                     |
| Shock              | Normal Truck Transport |
| Vibration          | Normal Truck Transport |
| Altitude           | 10000                  |

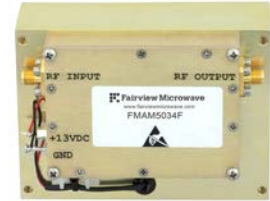

### Features:

- 0.8 GHz to 4.2 GHz Frequency Range
- Psat 1.5 Watts typ
- Small Signal Gain: 31 dB min
- Gain Flatness  $\pm 2.0$  dB max
- IP3 41 dBm typ
- 50 Ohms Input and Output Matched
- Unconditionally Stable
- Regulated Supply
- Heatsink and Fan

### Applications:

- Military Radio
- Communication Systems
- High Gain Driver Power Amplifier
- High Gain Output Power Amplifier

Fairview Microwave  
301 Leora Ln., Suite 100  
Lewisville, TX 75056  
Tel: 1-800-715-4396 / (972) 649-6678  
Fax: (972) 649-6689  
[www.fairviewmicrowave.com](http://www.fairviewmicrowave.com)  
[sales@fairviewmicrowave.com](mailto:sales@fairviewmicrowave.com)

**Compliance Certifications** (see [product page](#) for current document)

**Plotted and Other Data**

Notes:

- Values at 25 °C, sea level
- ESD Sensitive Material, Transport material in Approved ESD bags. Handle only in approved ESD Workstation.



## Amplifier Power-up Precautions

- 1.) Confirm that proper ESD precautions and controls are always in place before handling any Amplifier module.
- 2.) Confirm adequate thermal management is in place to effectively dissipate heat away from the Amplifier package. The Amplifier operational baseplate temperature must be within the operational temperature range stated in the Amplifier datasheet. Depending on the design and thermal requirements, using a heatsink with cooling fan is always recommended for safe reliable operation. A heat sink without a cooling fan may also be used. Damage caused from overheating will void the warranty.
- 3.) Confirm adequate system grounding is established. The DC power supply and Amplifier must have a common ground in order to operate properly.
- 4.) Power Amplifiers may require additional DC Current when initially powered-up. Depending on the design, the input current draw could range from an additional 10% to 100% above the maximum rated DC current of the Amplifier. This varies based on product part number.
- 5.) Confirm the DC power supply, if limited, is set to allow for additional start-up current that's rated for the Power Amplifier.
- 6.) Confirm the system is designed and calibrated for 50 ohms. Any impedance mismatch may cause performance issues.
- 7.) Perform a CALIBRATION (if required) with the loads before connecting the Amplifier to the Network Analyzer to ensure proper performance.
- 8.) Use a fixed attenuator between the signal source and input port of the Amplifier to optimize the input VSWR match.
- 9.) Confirm the input power level at the input port of the amplifier does not exceed the maximum rated limit for input power (as stated in the Amplifier datasheet).  
 $P_{in}$  for Small Signal Gain = P1dB-SSG-10 dB  
 $P_{in}$  for P1dB = P1dB-SSG+1 dB
- 10.) Confirm the Network Analyzer is always connected to the Amplifier first before DC power is applied to the Amplifier.
- 11.) As long as the input and output ports of the amplifier are connected to a 50Ohm load and RF signal power is applied, the Amplifier can be powered up with DC voltage.
- 12.) Confirm the Amplifier output load is matched for a 50 Ohm impedance and will not exceed the maximum rated VSWR or Return Loss limit for the Amplifier. Exceeding the maximum rated VSWR or Return Loss limit will result in reflected signal power that could damage the Amplifier and void the warranty.
- 13.) **Power Amplifier connected to an Antenna for signal transmission** - It's strongly recommended to use a high power fixed attenuator pad or an Isolator between the output port of the Amplifier and input port to the antenna. Any reflected signal power due to impedance mismatch will likely damage the Amplifier and void the warranty.
- 14.) The attenuator or isolator used at the output port of the Amplifier must be rated to handle the output power level and operational frequency band of the amplifier.

## Typical Performance Data

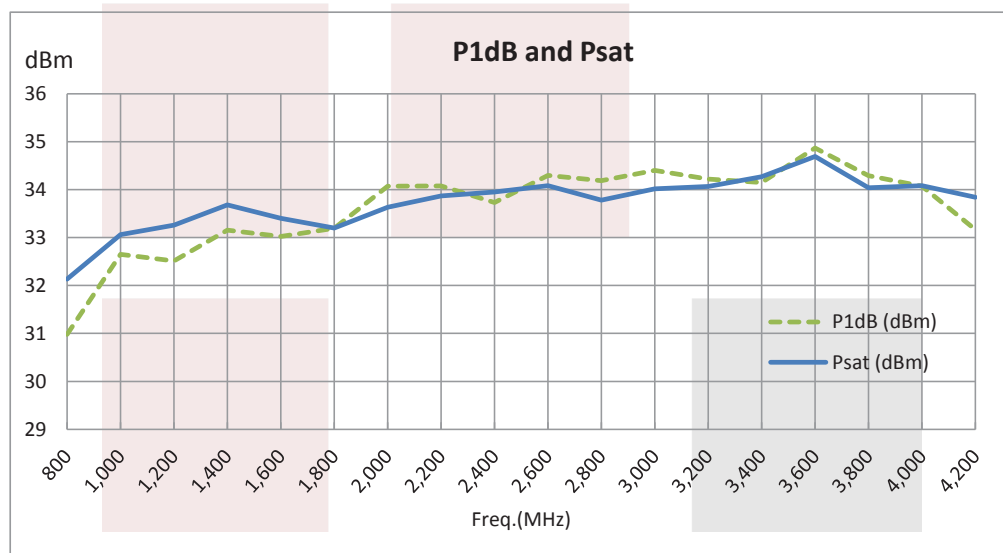
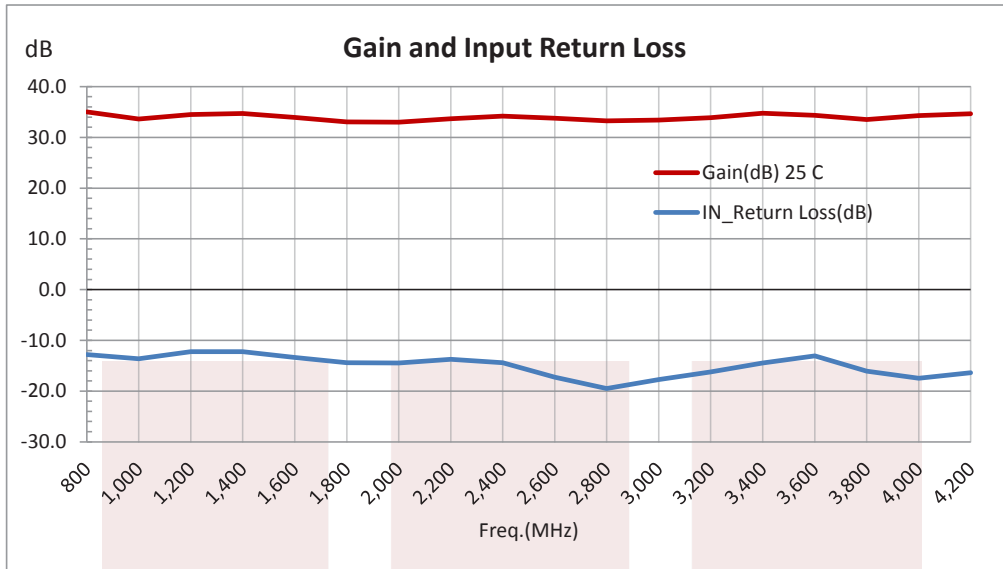

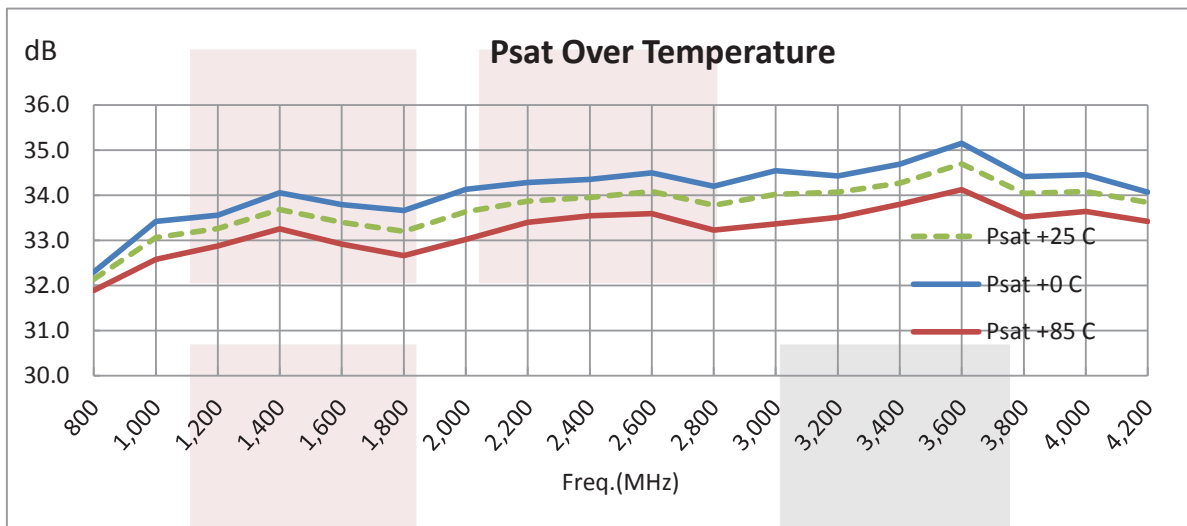
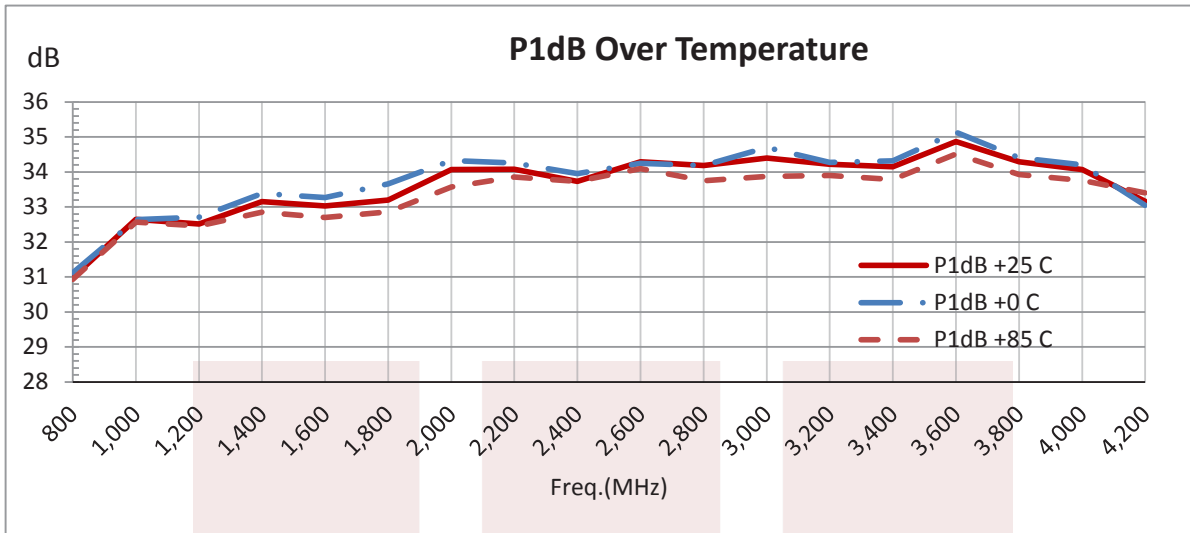

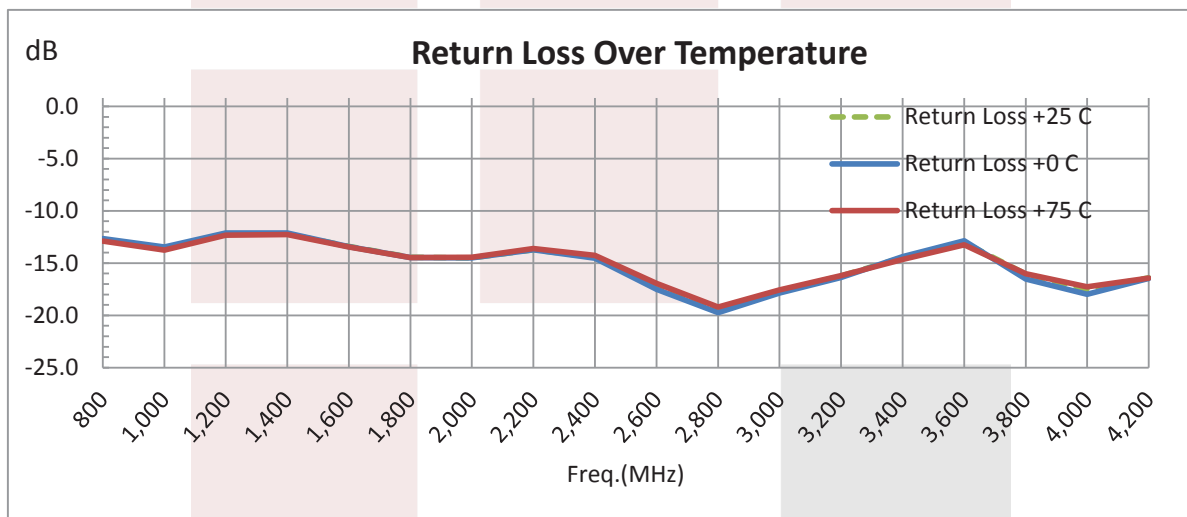
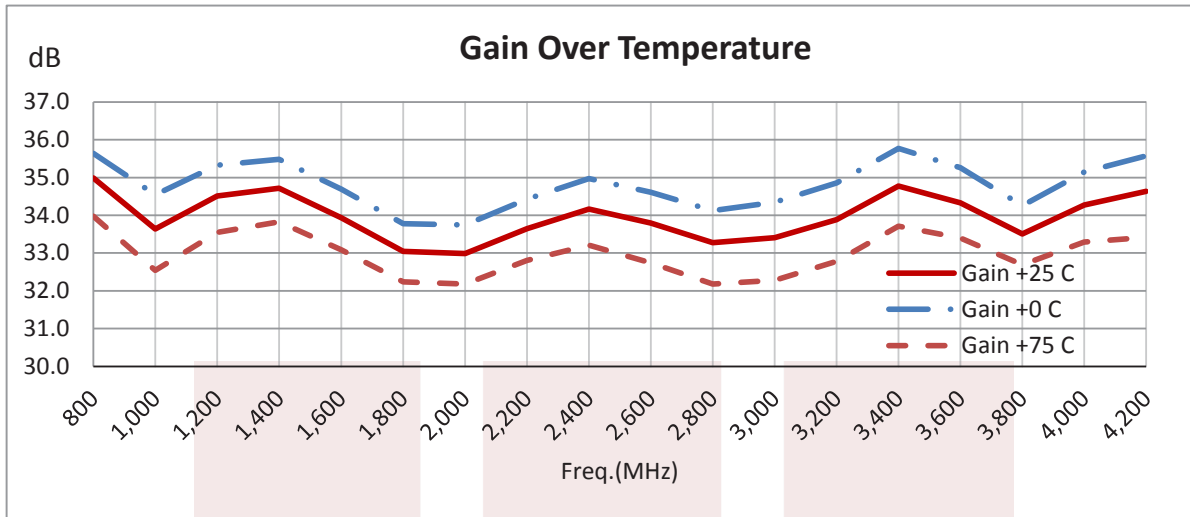

Medium Power GaAs Amplifier at 1.5 Watt Psat Operating from 800 MHz to 4.2 GHz with 41 dBm IP3, SMA w/ Heatsink and Fan from Fairview Microwave is in-stock and available to ship same-day. All of our RF/microwave products are available off-the-shelf from our ISO 9001:2008 certified facilities in Lewisville, Texas. Fairview Microwave is RF on-demand.

For additional information on this product, please click the following link: [Medium Power GaAs Amplifier at 1.5 Watt Psat Operating from 800 MHz to 4.2 GHz with 41 dBm IP3, SMA w/ Heatsink and Fan FMAM5034F](https://www.fairviewmicrowave.com/medium-power-amplifier-2watt-31db-fmam5034f-p.aspx)

URL: <https://www.fairviewmicrowave.com/medium-power-amplifier-2watt-31db-fmam5034f-p.aspx>

The information contained in this document is accurate to the best of our knowledge and representative of the part described herein. It may be necessary to make modifications to the part and/or the documentation of the part, in order to implement improvements. Fairview Microwave reserves the right to make such changes as required. Unless otherwise stated, all specifications are nominal. Fairview Microwave does not make any representation or warranty regarding the suitability of the part described herein for any particular purpose, and Fairview Microwave does not assume any liability arising out of the use of any part or documentation.

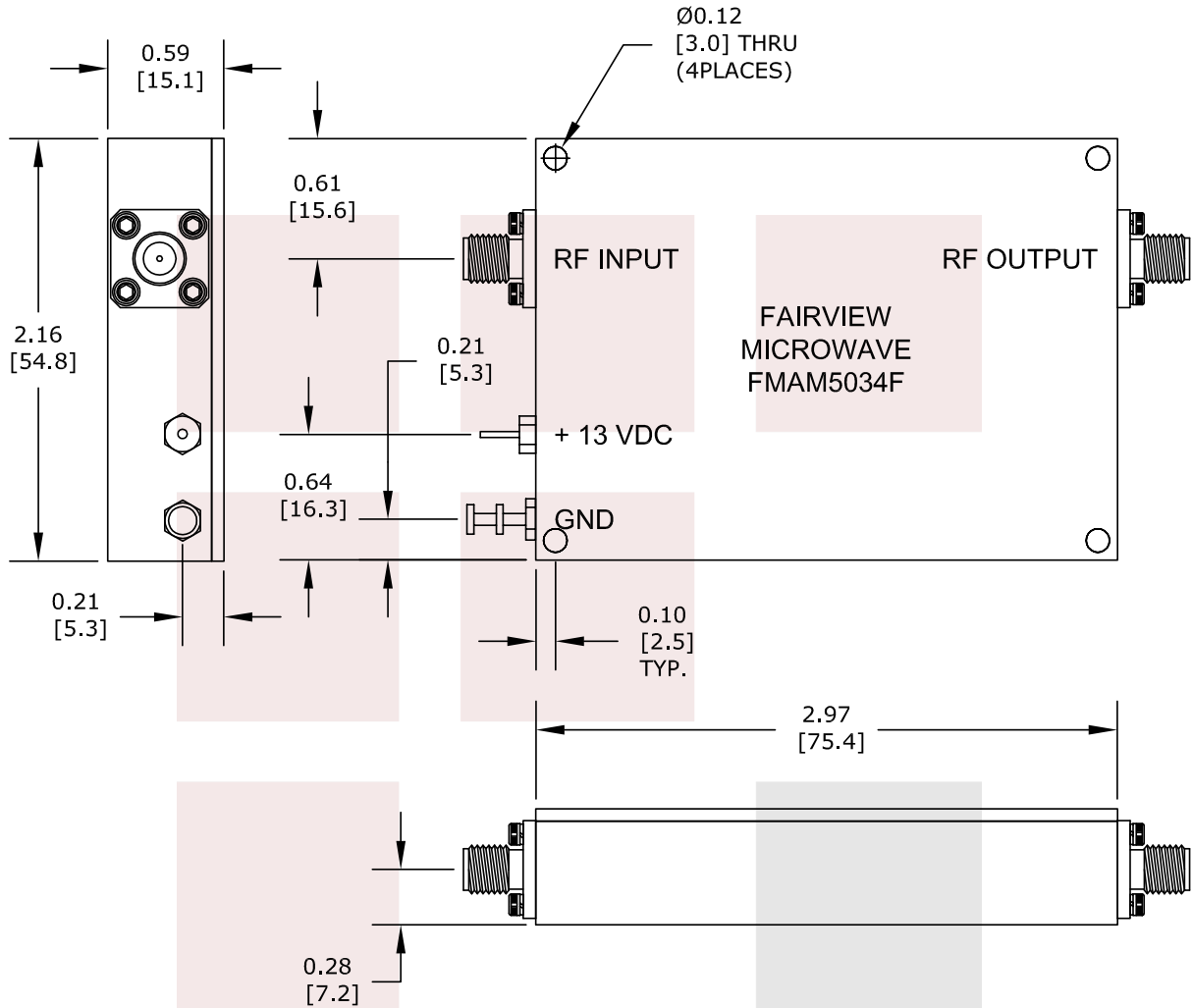

|  |        |   |       |                    |            |
|--|--------|---|-------|--------------------|------------|
| <b>FAIRVIEW MICROWAVE INC.</b><br>ALLEN, TX 75013 WWW.FAIRVIEWMICROWAVE.COM  |        | NOTES:<br>1. UNLESS OTHERWISE SPECIFIED ALL DIMENSIONS ARE NOMINAL.<br>2. ALL SPECIFICATIONS ARE SUBJECT TO CHANGE WITHOUT NOTICE AT ANY TIME.<br>3. DIMENSIONS ARE IN INCHES [mm]. |       |                    |            |
| TITLE<br>Medium Power GaAs Amplifier at 1.5 Watt Psat<br>Operating from 800 MHz to 4.2 GHz with 41 dBm IP3,<br>SMA w/ Heatsink and Fan |        | DWG NO<br>FMAM5034F   |       | CAGE CODE<br>3FKR5 |            |
| CAD FILE   | 120114 | SHEET   | SCALE | N/A                | SIZE A 150 |

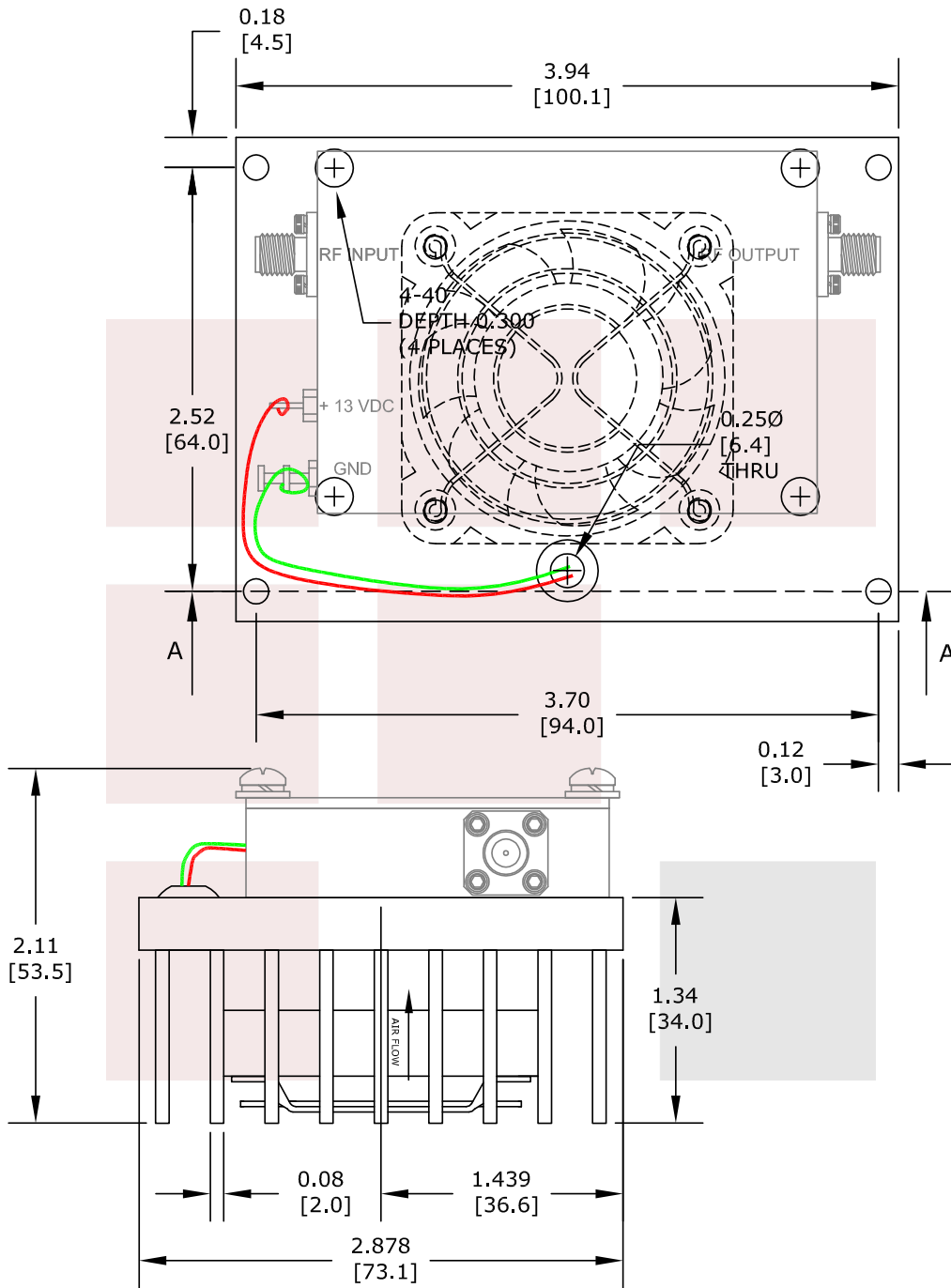

|  |        |   |       |                           |            |
|--|--------|---|-------|---------------------------|------------|
| <b>FAIRVIEW MICROWAVE INC.</b><br>ALLEN, TX 75013 WWW.FAIRVIEWMICROWAVE.COM  |        | NOTES:<br>1. UNLESS OTHERWISE SPECIFIED ALL DIMENSIONS ARE NOMINAL.<br>2. ALL SPECIFICATIONS ARE SUBJECT TO CHANGE WITHOUT NOTICE AT ANY TIME.<br>3. DIMENSIONS ARE IN INCHES [mm]. |       |                           |            |
| TITLE<br>Medium Power GaAs Amplifier at 1.5 Watt Psat<br>Operating from 800 MHz to 4.2 GHz with 41 dBm IP3,<br>SMA w/ Heatsink and Fan |        | DWG NO<br><b>FMAM5034F</b>  |       | CAGE CODE<br><b>3FKR5</b> |            |
| CAD FILE   | 120114 | SHEET   | SCALE | N/A                       | SIZE A 150 |



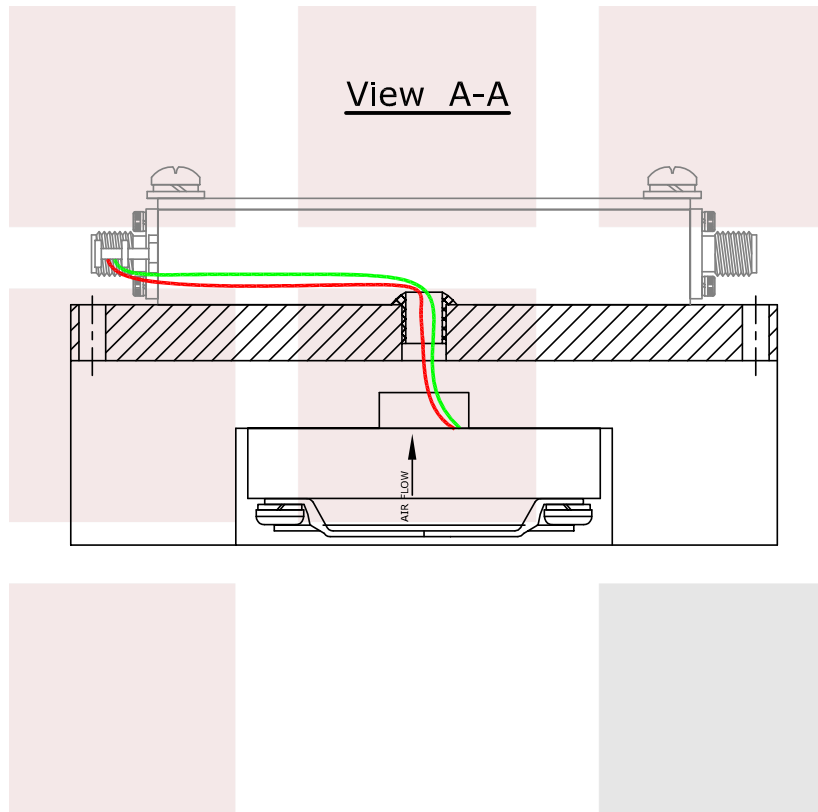

|  |        |   |       |                           |            |
|--|--------|---|-------|---------------------------|------------|
| <b>FAIRVIEW MICROWAVE INC.</b><br>ALLEN, TX 75013 WWW.FAIRVIEWMICROWAVE.COM  |        | NOTES:<br>1. UNLESS OTHERWISE SPECIFIED ALL DIMENSIONS ARE NOMINAL.<br>2. ALL SPECIFICATIONS ARE SUBJECT TO CHANGE WITHOUT NOTICE AT ANY TIME.<br>3. DIMENSIONS ARE IN INCHES [mm]. |       |                           |            |
| TITLE<br>Medium Power GaAs Amplifier at 1.5 Watt Psat<br>Operating from 800 MHz to 4.2 GHz with 41 dBm IP3,<br>SMA w/ Heatsink and Fan |        | DWG NO<br><b>FMAM5034F</b>  |       | CAGE CODE<br><b>3FKR5</b> |            |
| CAD FILE   | 120114 | SHEET   | SCALE | N/A                       | SIZE A 150 |