

1700 to 2400 MHz SMA GaN Power Amplifier, 35W, L & S Bands, 28V, 40% Efficiency and Class AB

The FMAM5073 is a Class AB high power amplifier that operates in L and S bands from 1700 MHz to 2400 MHz and generates up to 35 Watts RF output power. The module utilizes the latest Gallium Nitride (GaN) semiconductor technology with 40% power efficiency. The package design features a small form factor of <math><10\text{in}^3</math> that's ideal for size, weight, and power (SWaP) constrained applications used in broadband RF telemetry, tactical communication, electronic warfare, and unmanned aircraft systems, as well as software defined radios. Impressive typical performance includes 54 dB of linear gain, 2.0:1 VSWR, +44 dBm third order intercept point, and low harmonic suppression of -25 dBc. Additionally with a nominal 0 dBm (1 mW) RF input power, the amplifier can provide 44 dB of gain and near-constant envelope waveforms. Operating voltage is +28 Vdc with 3.6A of DC current. Additional features include overvoltage protection, reverse voltage protection, and logic on/off control. The rugged Mil-Grade assembly supports female SMA RF input/output connectors and a micro-D 9 pin socket command control connector with an accessory cable assembly included. The operating baseplate temperature range is -40°C to +85°C and the unit is guaranteed to withstand up to 95% relative humidity, altitude levels up to 30,000 ft, and random vibration and shock profiles (see chart below). Pasternak also offers an accessory Harmonic filter option, model FMHFL0000 that can be used at the output of the FMAM5073 power amplifier. This lowpass RF filter has low insertion loss with power handling up to 50W and specifically designed to reduce harmonics at the output of transmitters operating at up through L and S Bands and offers rejection levels of greater than 25 dB from 3.25 GHz to 5 GHz. The filter is offered in a miniature SMA connectorized package.

Electrical Specifications

(TA = +25°C, DC Voltage = 28Volts , DC Current = 3.6A)

Description	Min	Typ	Max	Unit
Frequency Range	1.7		2.4	GHz
Small Signal Gain		54		dB
Gain Flatness		±3		dB
Input Power (CW)		+0		dBm
Psat	20	35		Watts
Efficiency (PAE)		45		%
P1dB		+42		dBm
Output 3rd Order Intercept Point		+44		dBm
Output Mismatch			10:1	
2nd Harmonics		-25		dBc
3rd Harmonics		-25		dBc
Impedance (Input)		50		Ohms
Impedance (Output)		50		Ohms
Input VSWR		2:1		
Switching Speed for On/Off Switch Gate			2	usec
Operating DC Voltage	27	28	30	Volts
Operating DC Current		3.6		A
Quiescent Current Bias		850		mA
(RF Enable Low)				
Quiescent Current Unbiased		100		mA
(RF Enable Floating)				



Features:

- 35W GaN High Power Amplifier
- L & S Band Class AB Design
- Extended Frequency Range: 1700 MHz to 2400 MHz
- 54 dB linear Gain
- VSWR: 2:0:1
- +44 dBm IP3
- PAE: 40%
- Small Form Factor Rugged Mil-Grade Package
- 50 Ohm Design
- Female SMA RF Connectors
- +28Vdc @ 3.6A DC Current
- -40°C to +85°C Operating Baseplate Temperature
- Output Harmonic Filter Accessory Option

Applications:

- Broadband RF Telemetry
- RF Communications Systems
- Electronic Warfare - Airborne Electronic Attack
- Unmanned Aircraft Systems (UAS), Group 2 & 3
- Unmanned Ground Vehicles (UGV), Software Defined Radios
- Data Links
- Transmitters
- Test & Measurement
- Telecom Infrastructure

Fairview Microwave
 301 Leora Ln., Suite 100
 Lewisville, TX 75056
 Tel: 1-800-715-4396 / (972) 649-6678
 Fax: (972) 649-6689
www.fairviewmicrowave.com
sales@fairviewmicrowave.com

Operating Temperature Range -40 +85 °C

Performance by Frequency

Description	F1	F2	F3	Units
Frequency Condition	800	1500	2000	MHz
Output Power @ 1dB Compression, Typ	30.00	32	30	dBm
Small Signal Gain, Typ (@-40dBm input)	52.0	50	49	dB

Absolute Maximum Rating

Parameter	Rating	Unit
Max Device Voltage	32	V
Max Device Current	3.75	A
Max RF Input Power, $Z_L = 50 \Omega$	12	dBm
Max Operating Temperature (ambient)	85	°C
Max Operating Temperature (baseplate)	85	°C
Max Storage Temperature	85	°C



ESD Sensitive Material,
Transport material in
Approved ESD bags. Handle
only in approved
ESD Workstation.

Mechanical Specifications

Size

Length	4.5 in [114.3 mm]
Width	3.5 in [88.9 mm]
Height	0.61 in [15.49 mm]
Weight	0.6 lbs [272.16 g]
Input Connector	SMA Female
Output Connector	SMA Female
Bias Connector	9-Pin Micro-D Socket

Environmental Specifications

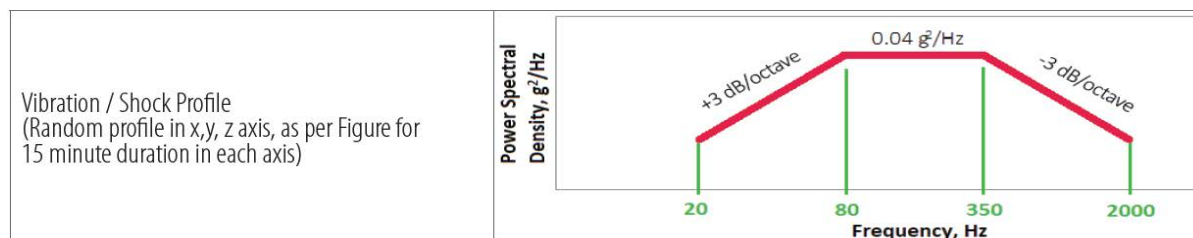

Temperature

Operating Range	-40 to +85 deg C
Storage Range	-55 to +85 deg C
Humidity	95% Non-Condensing
Altitude	MIL-STD-810F Method 5004

Compliance Certifications (see [product page](#) for current document)

Plotted and Other Data

Notes:

- Values at 25 °C, sea level

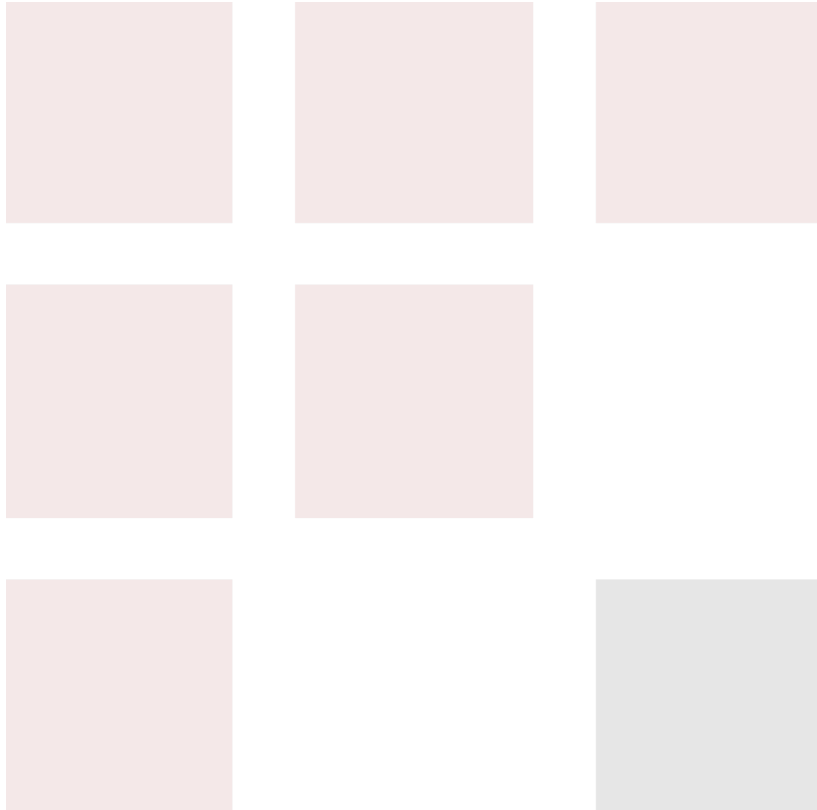

Amplifier Power-up Precautions

- 1.) Confirm that proper ESD precautions and controls are always in place before handling any Amplifier module.
- 2.) Confirm adequate thermal management is in place to effectively dissipate heat away from the Amplifier package. The Amplifier operational baseplate temperature must be within the operational temperature range stated in the Amplifier datasheet. Depending on the design and thermal requirements, using a heatsink with cooling fan is always recommended for safe reliable operation. A heat sink without a cooling fan may also be used. Damage caused from overheating will void the warranty.
- 3.) Confirm adequate system grounding is established. The DC power supply and Amplifier must have a common ground in order to operate properly.
- 4.) Power Amplifiers may require additional DC Current when initially powered-up. Depending on the design, the input current draw could range from an additional 10% to 100% above the maximum rated DC current of the Amplifier. This varies based on product part number.
- 5.) Confirm the DC power supply, if limited, is set to allow for additional start-up current that's rated for the Power Amplifier.
- 6.) Confirm the system is designed and calibrated for 50 ohms. Any impedance mismatch may cause performance issues.
- 7.) Perform a CALIBRATION (if required) with the loads before connecting the Amplifier to the Network Analyzer to ensure proper performance.
- 8.) Use a fixed attenuator between the signal source and input port of the Amplifier to optimize the input VSWR match.
- 9.) Confirm the input power level at the input port of the amplifier does not exceed the maximum rated limit for input power (as stated in the Amplifier datasheet).
 P_{in} for Small Signal Gain = P1dB-SSG-10 dB
 P_{in} for P1dB = P1dB-SSG+1 dB
- 10.) Confirm the Network Analyzer is always connected to the Amplifier first before DC power is applied to the Amplifier.
- 11.) As long as the input and output ports of the amplifier are connected to a 50Ohm load and RF signal power is applied, the Amplifier can be powered up with DC voltage.
- 12.) Confirm the Amplifier output load is matched for a 50 Ohm impedance and will not exceed the maximum rated VSWR or Return Loss limit for the Amplifier. Exceeding the maximum rated VSWR or Return Loss limit will result in reflected signal power that could damage the Amplifier and void the warranty.
- 13.) **Power Amplifier connected to an Antenna for signal transmission** - It's strongly recommended to use a high power fixed attenuator pad or an Isolator between the output port of the Amplifier and input port to the antenna. Any reflected signal power due to impedance mismatch will likely damage the Amplifier and void the warranty.
- 14.) The attenuator or isolator used at the output port of the Amplifier must be rated to handle the output power level and operational frequency band of the amplifier.

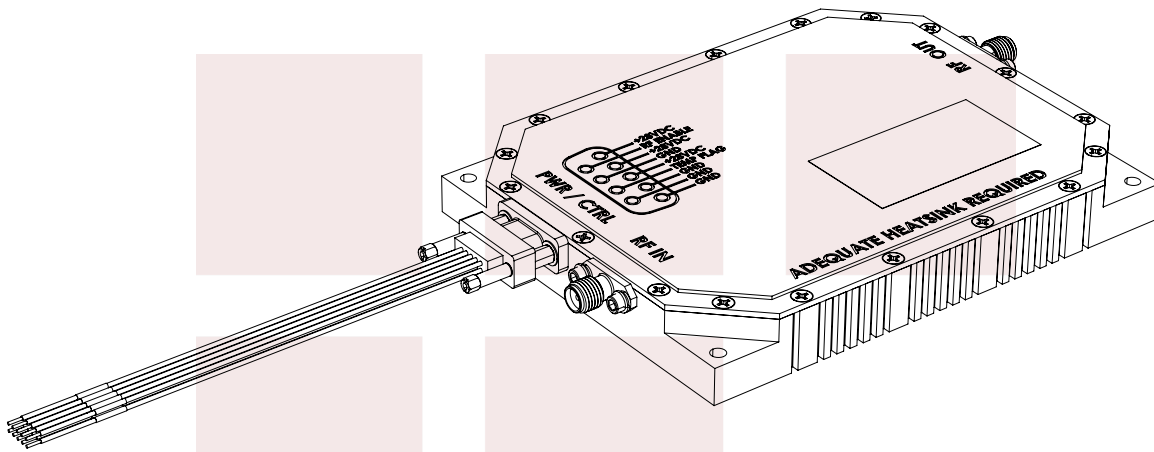
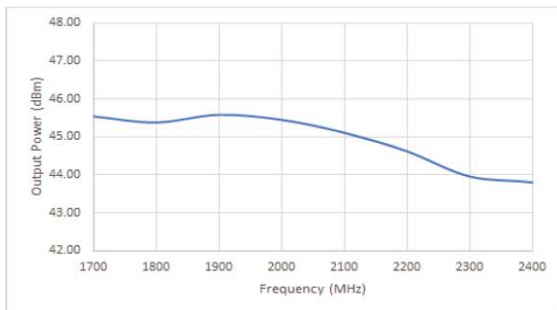

illustration of Amplifier & Interface Cable

Typical Performance Data

Output Power [0dBm Input Power]



Small Signal Gain [-40dBm Input Power]

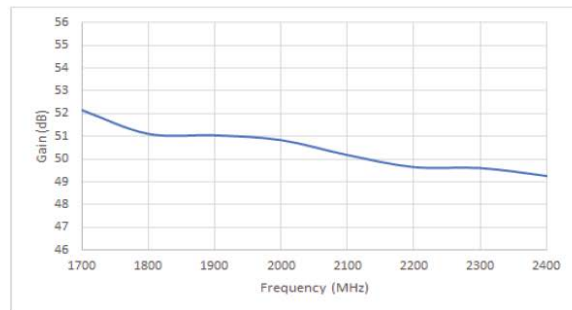

Output Power vs. Input Power

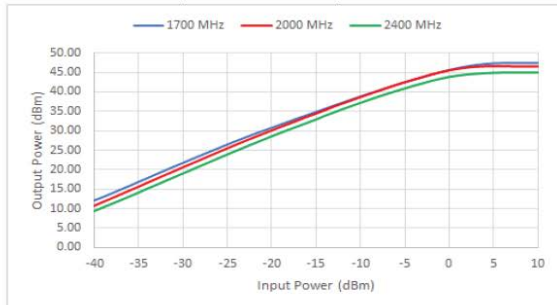

P1dB & P3dB

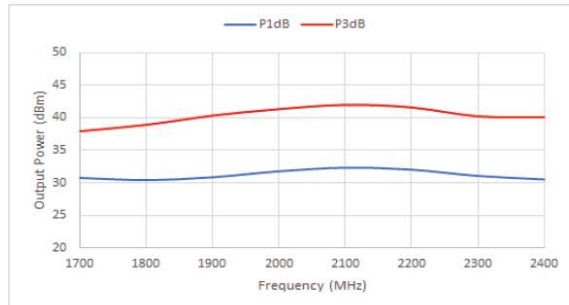

Efficiency vs. Output Power

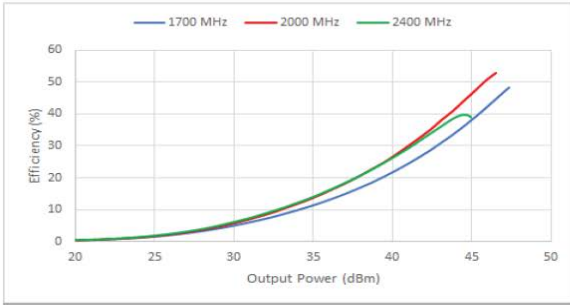

Harmonics [@Psat]

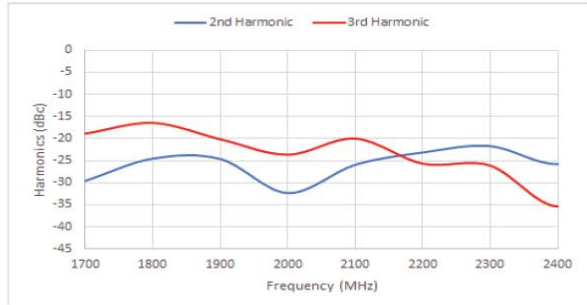

Output Power vs. Temperature [Baseplate]

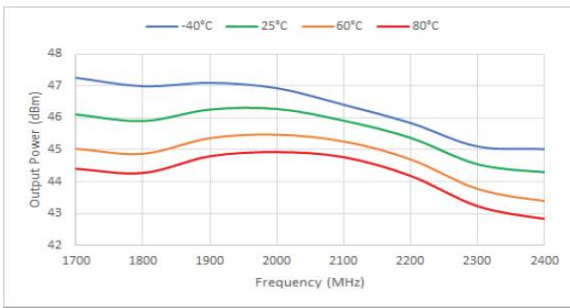

Error Vector Magnitude vs. Output Power [QPSK, 1Msps, 35% Roll Off Rate]



Error Vector Magnitude vs. Output Power [16QAM, 2Msps, 35% Roll Off Rate]

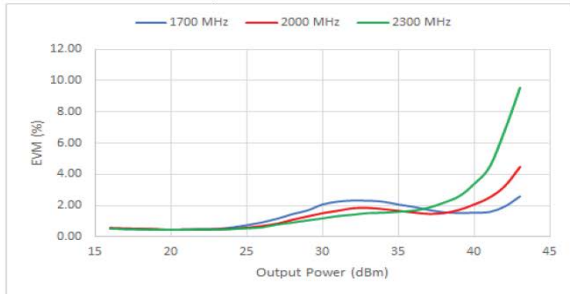

Error Vector Magnitude vs. Output Power [64QAM, 5Msps, 10% Roll Off Rate]

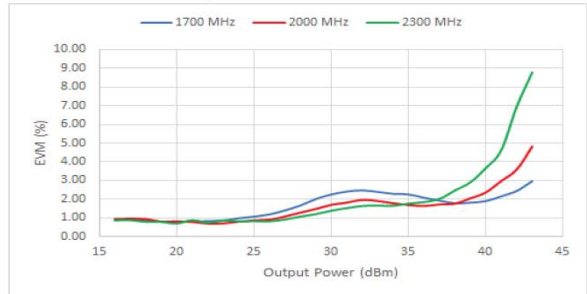

OIP3 [20dBm per tone, 1MHz spacing]

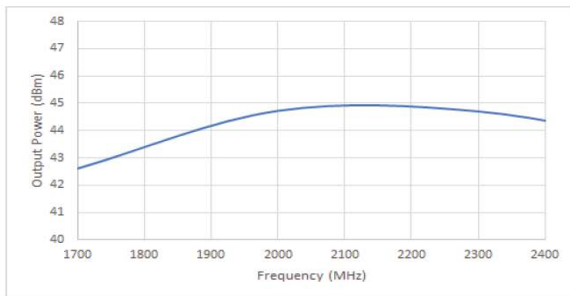

Input VSWR

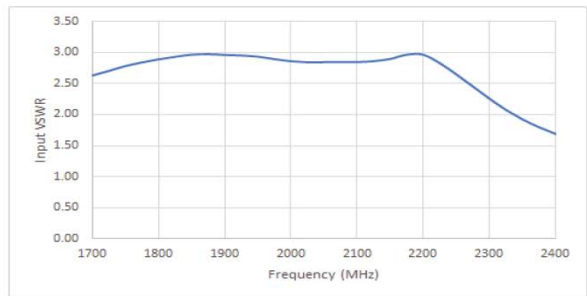

1700 to 2400 MHz SMA GaN Power Amplifier, 35W, L & S Bands, 28V, 40% Efficiency and Class AB from Fairview Microwave is in-stock and available to ship same-day. All of our RF/microwave products are available off-the-shelf from our ISO 9001:2008 certified facilities in Lewisville, Texas. Fairview Microwave is RF on-demand.

For additional information on this product, please click the following link: [1700 to 2400 MHz SMA GaN Power Amplifier, 35W, L & S Bands, 28V, 40% Efficiency and Class AB FMAM5073](#)

URL: <https://www.fairviewmicrowave.com/54db-high-power-high-gain-amplifier-3watt-fmam5073-p.aspx>

The information contained in this document is accurate to the best of our knowledge and representative of the part described herein. It may be necessary to make modifications to the part and/or the documentation of the part, in order to implement improvements. Fairview Microwave reserves the right to make such changes as required. Unless otherwise stated, all specifications are nominal. Fairview Microwave does not make any representation or warranty regarding the suitability of the part described herein for any particular purpose, and Fairview Microwave does not assume any liability arising out of the use of any part or documentation.

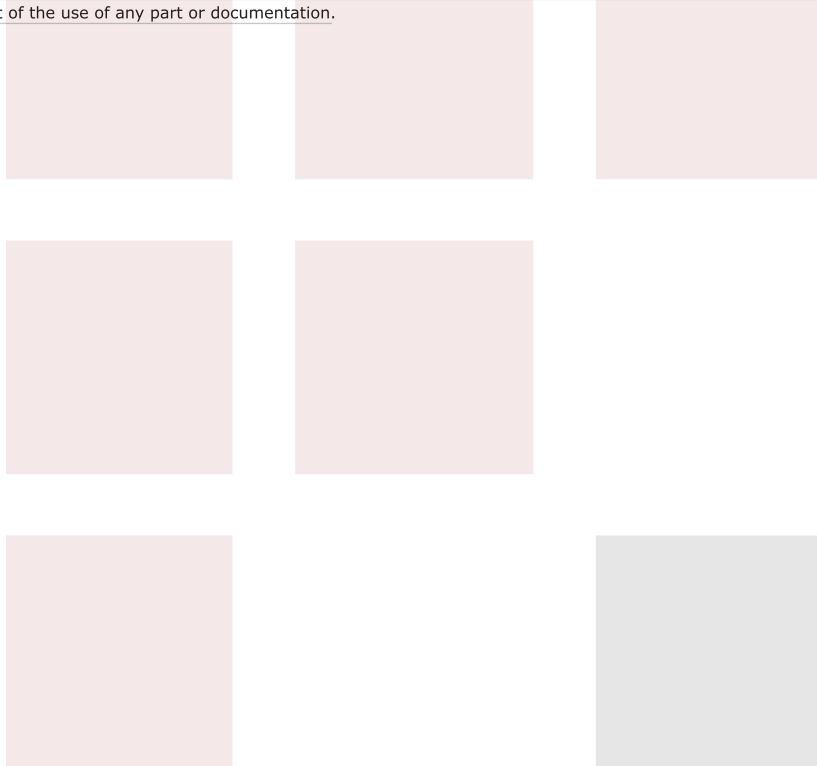

REVISIONS			
REV.	DESCRIPTION	DATE	APPROVED
A	INITIAL RELEASE	5/28/2020	T.GALLA

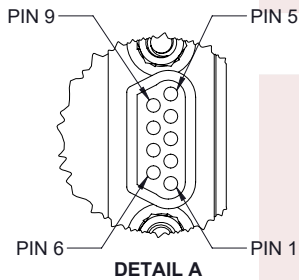
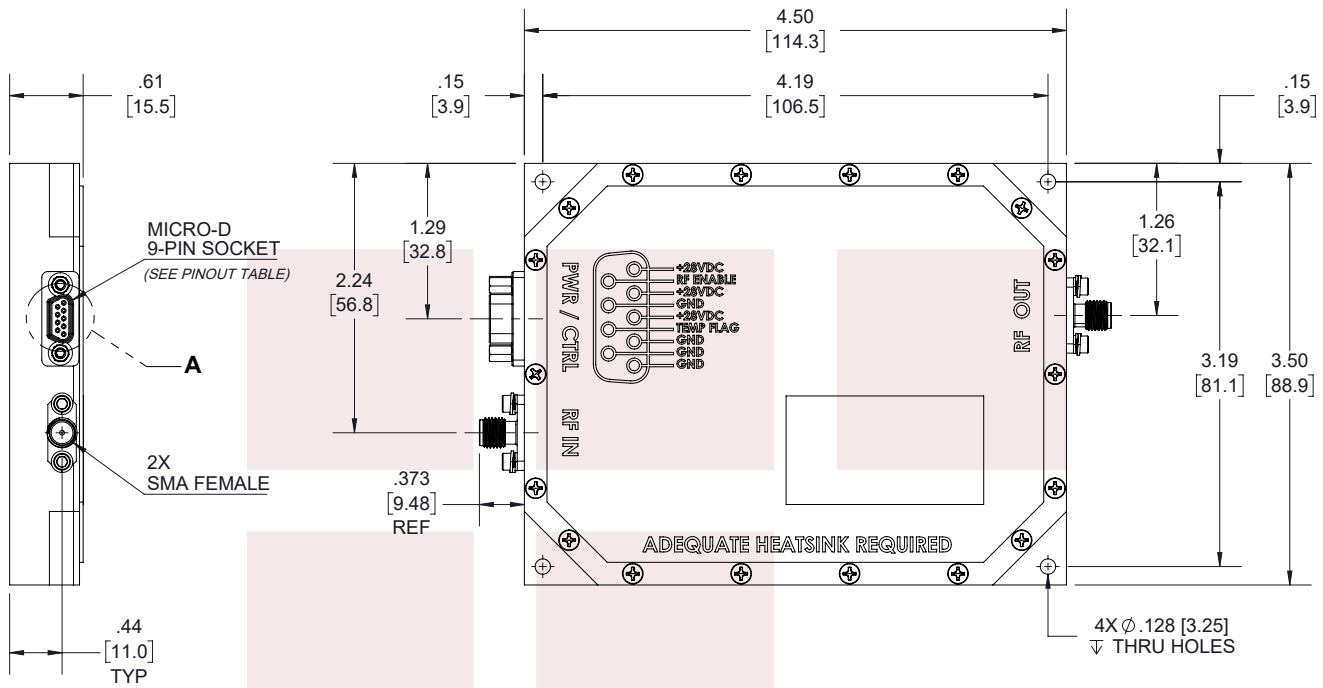

Pinout	
Pin #	Function
3,4,5	DC Power (+28 Volts)
1,2,6,8	Ground
7	Over Temperature Flag (Low = Temperature Fault)
9	RF Enable (GND to Enable)

LABEL

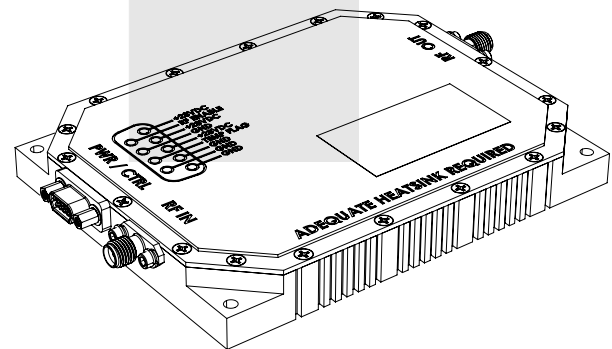

THESE COMMODITIES, TECHNOLOGY OR SOFTWARE WERE EXPORTED FROM THE UNITED STATES IN ACCORDANCE WITH THE EXPORT ADMINISTRATION REGULATIONS. DIVERSION CONTRARY TO U.S. LAW PROHIBITED.



TITLE
1700 to 2400 MHz SMA GaN Power Amplifier, 35W, L & S Bands, 28V, 40% Efficiency and Class AB

UNLESS OTHERWISE SPECIFIED LEADING DIMENSIONS ARE INCHES
DIMENSIONS IN [] ARE MILLIMETERS

TOLERANCES: CABLE LENGTH (L) TOLERANCES:

.X ± .2 [.508]	FRACTIONS ± 1/32	L ≤ 12 [305] = +1 [25] / -0
.XX ± .02 [.51]	ANGLES ± 1°	12 [305] < L ≤ 60 [1524] = +2 [51] / -0
.XXX ± .005 [.13]		60 [1524] < L ≤ 120 [3048] = +4 [102] / -0
		120 [3048] < L ≤ 300 [7620] = +6 [152] / -0
		300 [7620] < L = +5%L / -0

THIRD-ANGLE PROJECTION



THE INFORMATION AND DESIGN IN THIS DOCUMENT IS THE PROPERTY OF FAIRVIEW MICROWAVE CORPORATION. ALL RIGHTS RESERVED.

SHEET 1 OF 3

ALL DIMENSIONS SHOWN ARE FOR REFERENCE ONLY.

SCALE N/A

SIZE A	CAGE CODE 3FKR5	DRAWN BY K.DANG	ITEM NO. FMAM5073	REV. A
--------	-----------------	-----------------	-------------------	--------

T-Rev.D

INTERFACE CABLE

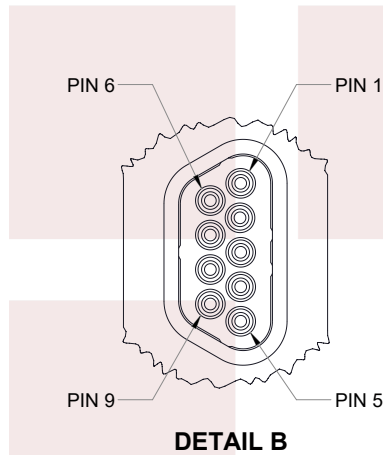
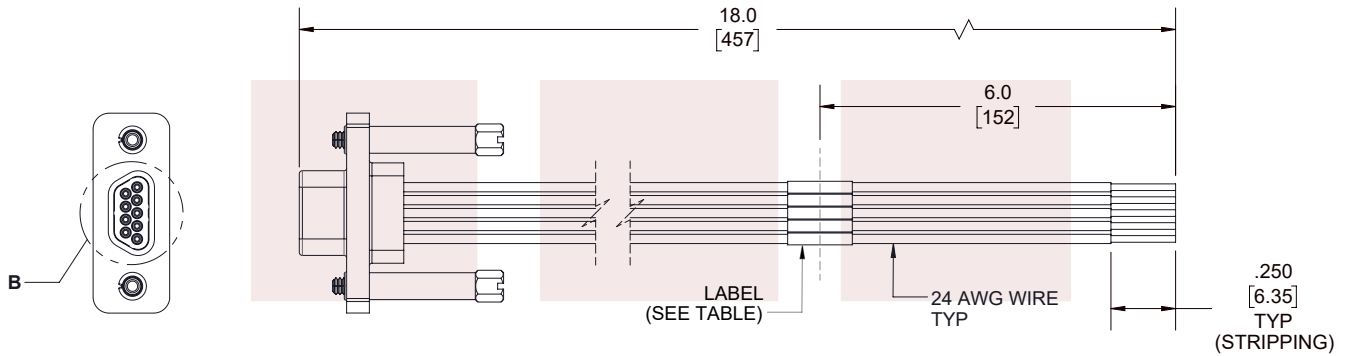

Pinout		
Pin #	Wire Color	Label
1	Black	GND
2	Brown	GND
3	Red	+ 28V
4	Orange	+ 28V
5	Yellow	+ 28V
6	Green	GND
7	Blue	Temp Flag
8	Purple	GND
9	Gray	RF Enable

THESE COMMODITIES, TECHNOLOGY OR SOFTWARE WERE EXPORTED FROM THE UNITED STATES IN ACCORDANCE WITH THE EXPORT ADMINISTRATION REGULATIONS. DIVERSION CONTRARY TO U.S. LAW PROHIBITED.

TITLE
1700 to 2400 MHz SMA GaN Power Amplifier, 35W, L & S Bands, 28V, 40% Efficiency and Class AB

UNLESS OTHERWISE SPECIFIED LEADING DIMENSIONS ARE INCHES
DIMENSIONS IN [] ARE MILLIMETERS

TOLERANCES:		CABLE LENGTH (L) TOLERANCES:	
.X = ±.2 [5.08]	FRACTIONS ± 1/32	L ≤ 12 [305] = +1 [25] / -0	
.XX = ±.02 [.51]	ANGLES ± 1°	12 [305] < L ≤ 60 [1524] = +2 [51] / -0	
.XXX = ±.005 [.13]		60 [1524] < L ≤ 120 [3048] = +4 [102] / -0	
		120 [3048] < L ≤ 300 [7620] = +6 [152] / -0	
		300 [7620] < L = +5%L / -0	

THIRD-ANGLE PROJECTION

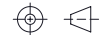

THE INFORMATION AND DESIGN IN THIS DOCUMENT IS THE PROPERTY OF FAIRVIEW MICROWAVE CORPORATION. ALL RIGHTS RESERVED.

SHEET 2 OF 3

ALL DIMENSIONS SHOWN ARE FOR REFERENCE ONLY.

SCALE N/A

SIZE A	CAGE CODE 3FKR5	DRAWN BY K.DANG	ITEM NO. FMAM5073	REV A
--------	-----------------	-----------------	-------------------	-------

T-Rev.D