

1 dB Fixed Attenuator QMA Male To QMA Female Up To 6 GHz Rated To 1 Watt

Fairview Microwave carries a broad selection of fixed attenuators with a wide range of attenuation levels, frequency ranges, and power dissipation ranges. Also known as RF pads, RF microwave attenuators lower the amplitude of a signal (or attenuate) a known amount. These attenuator pads can be used in a wide variety of applications including reducing a signal level to protect measurement equipment or other circuitry, extending the range of power meters and amplifiers, and impedance matching circuits by reducing the VSWR seen by adjacent components. RF attenuators can prevent signal overload in amplifiers, receivers and detectors, adjusting the signal level to a range that is optimal.

Few RF components are as commonly used as fixed coaxial attenuators, and Fairview Microwave carries one of the largest in-stock varieties and ships them same day. The FMAP1002-1 is a 1 dB Fixed Attenuator that operates from DC to 6 GHz and is rated to 1 Watt. The versatile coaxial package uses QMA male to QMA female connectors and is also RoHS compliant.



Features:

- Bidirectional
- DC to 6 GHz Frequency Range
- Attenuation 1±0.5 dB
- Max Power 2 Watts (CW)
- VSWR < 1.25:1

Applications:

- Instrumentation
- Precision measurements
- Prototyping and characterization
- Production systems

Electrical Specifications

Description	Min	Typ	Max	Units
Frequency Range	DC		6	GHz
Impedance		50		Ohms
Nominal Attenuation		1		dB
Input Power, CW			1	Watts
Input Power, Peak 1 μs, 1%			100	Watts

Specifications by Frequency

Description	F1	F2	F3	F4	F5	Units
Range	DC to 2	2 to 6				GHz
VSWR, Max	1.2:1	1.3:1				
Atten Accuracy, Typ	±0.3	±0.5				dB

Mechanical Specifications

Size

Configuration

Design Fixed

Connectors

Description	Connector 1	Connector 2
Type	QMA Male	QMA Female

Environmental Specifications

Temperature

Operating Range -40 to +85 deg C

Fairview Microwave
1130 Junction Dr. #100
Allen, TX 75013
Tel: 1-800-715-4396 / (972) 649-6678
Fax: (972) 649-6689
www.fairviewmicrowave.com
sales@fairviewmicrowave.com

Compliance Certifications (see [product page](#) for current document)

Plotted and Other Data

Notes:

1 dB Fixed Attenuator QMA Male To QMA Female Up To 6 GHz Rated To 1 Watt from Fairview Microwave is in-stock and available to ship same-day. All of our RF/microwave products are available off-the-shelf from our ISO 9001:2008 certified facilities in Allen, Texas. Fairview Microwave is RF on-demand.

For additional information on this product, please click the following link: [1 dB Fixed Attenuator QMA Male To QMA Female Up To 6 GHz Rated To 1 Watt FMAP1002-1](#)

URL: <https://www.fairviewmicrowave.com/1db-fixed-attenuator-qma-male-qma-female-1-watt-fmap1002-1-p.aspx>

The information contained in this document is accurate to the best of our knowledge and representative of the part described herein. It may be necessary to make modifications to the part and/or the documentation of the part, in order to implement improvements. Fairview Microwave reserves the right to make such changes as required. Unless otherwise stated, all specifications are nominal. Fairview Microwave does not make any representation or warranty regarding the suitability of the part described herein for any particular purpose, and Fairview Microwave does not assume any liability arising out of the use of any part or documentation.

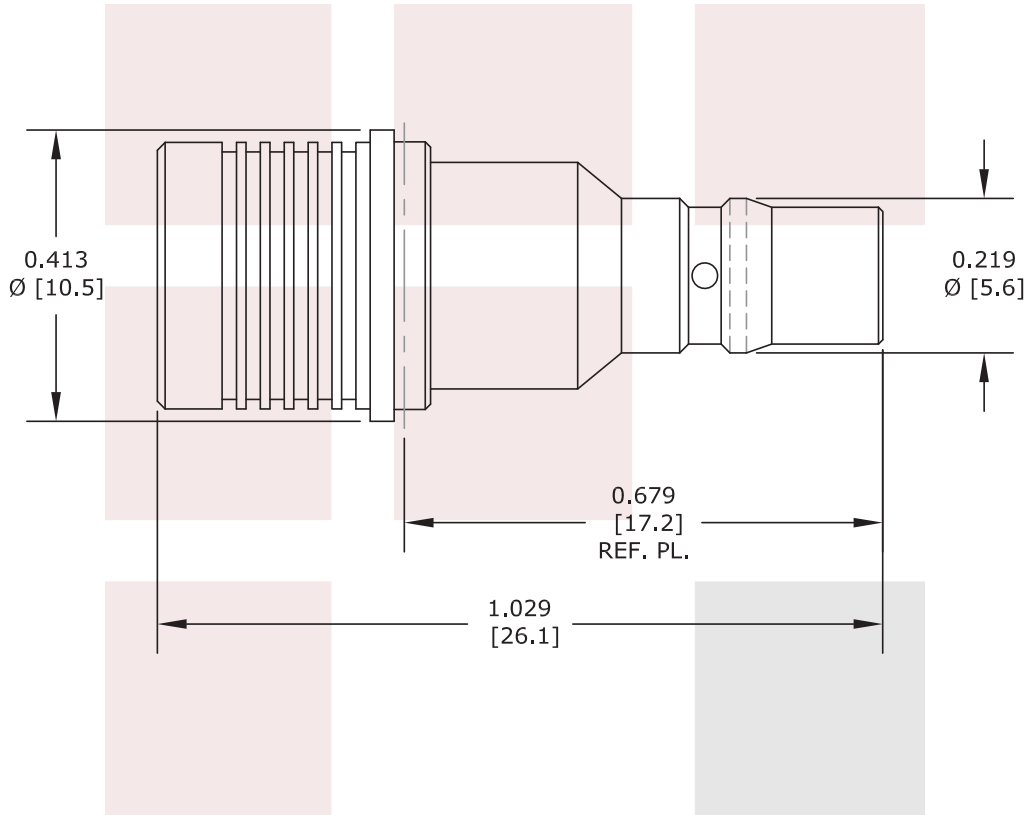

STANDARD TOLERANCES	
.X	±0.2
.XX	±0.1
.XXX	±0.05

*STANDARD TOLERANCES APPLY ONLY TO DIMENSIONS IN INCHES

FAIRVIEW MICROWAVE INC. ALLEN, TX 75013 WWW.FAIRVIEWMICROWAVE.COM		NOTES: 1. UNLESS OTHERWISE SPECIFIED ALL DIMENSIONS ARE NOMINAL. 2. ALL SPECIFICATIONS ARE SUBJECT TO CHANGE WITHOUT NOTICE AT ANY TIME. 3. DIMENSIONS ARE IN INCHES [mm].			
TITLE 1 dB Fixed Attenuator QMA Male To QMA Female Up To 6 GHz Rated To 1 Watt		DWG NO FMAP1002-1		CAGE CODE 3FKR5	
CAD FILE	061417	SHEET	SCALE	N/A	SIZE A 2233