

40 dB Fixed Attenuator, 4.3-10 Male (Plug) to 4.3-10 Female (Jack) Up to 6 GHz Rated to 100 Watts, 1.35:1 VSWR

Fairview Microwave carries a broad selection of fixed attenuators with a wide range of attenuation levels, frequency ranges, and power dissipation ranges. Also known as RF pads, RF microwave attenuators lower the amplitude of a signal (or attenuate) a known amount. These attenuator pads can be used in a wide variety of applications including reducing a signal level to protect measurement equipment or other circuitry, extending the range of power meters and amplifiers, and impedance matching circuits by reducing the VSWR seen by adjacent components. RF attenuators can prevent signal overload in amplifiers, receivers and detectors, adjusting the signal level to a range that is optimal.

Few RF components are as commonly used as fixed coaxial attenuators, and Fairview Microwave carries one of the largest in-stock varieties and ships them same day. The FMAT7453-40 is a 40 dB Fixed Attenuator that operates from DC to 6 GHz and is rated to 100 Watts. The versatile coaxial package uses 4.3-10 male to 4.3-10 female connectors and is also RoHS compliant.

Electrical Specifications

Description	Min	Typ	Max	Units
Frequency Range	DC		6	GHz
Impedance		50		Ohms
Nominal Attenuation		40		dB
Attenuation Accuracy			±1	dB
VSWR			1.35:1	
Input Power, CW			100	Watts
Input Power, Peak 5µs PW, 2% duty cycle			5	kWatts

Mechanical Specifications

Size	
Length	6.26 in [159 mm]
Width/Diameter	1.772 in [45.01 mm]
Height	1.772 in [45.01 mm]
Weight	0.573 lbs [259.91 g]
Body Material and Plating	Aluminum, Black Anodized

Configuration

Design	Fixed
Package Style	Connectorized

Connectors

Description	Connector 1	Connector 2
Type	4.3-10 Male	4.3-10 Female
Contact Material & Plating	Brass, Gold	Beryllium Copper, Gold
Body Material & Plating	Brass, Nickel	Brass, Nickel



Features:

- DC to 6 GHz Frequency Range
- 4.3-10 Connectorized Design
- Attenuation 40 dB ±1.0 dB
- Max Power 100 Watts (CW)
- Maximum VSWR of 1.35:1

Applications:

- Instrumentation
- Precision Measurements
- Prototyping and Characterization
- Production Systems

Fairview Microwave
 301 Leora Ln., Suite 100
 Lewisville, TX 75056
 Tel: 1-800-715-4396 / (972) 649-6678
 Fax: (972) 649-6689
www.fairviewmicrowave.com
sales@fairviewmicrowave.com

Environmental Specifications

Temperature

Operating Range -55 to +125 deg C
Storage Range -55 to +125 deg C

Compliance Certifications (see [product page](#) for current document)

Plotted and Other Data

Notes:

40 dB Fixed Attenuator, 4.3-10 Male (Plug) to 4.3-10 Female (Jack) Up to 6 GHz Rated to 100 Watts, 1.35:1 VSWR from Fairview Microwave is in-stock and available to ship same-day. All of our RF/microwave products are available off-the-shelf from our ISO 9001:2008 certified facilities in Lewisville, Texas. Fairview Microwave is RF on-demand.

For additional information on this product, please click the following link: [40 dB Fixed Attenuator, 4.3-10 Male \(Plug\) to 4.3-10 Female \(Jack\) Up to 6 GHz Rated to 100 Watts, 1.35:1 VSWR FMAT7453-40](#)

URL:

The information contained in this document is accurate to the best of our knowledge and representative of the part described herein. It may be necessary to make modifications to the part and/or the documentation of the part, in order to implement improvements. Fairview Microwave reserves the right to make such changes as required. Unless otherwise stated, all specifications are nominal. Fairview Microwave does not make any representation or warranty regarding the suitability of the part described herein for any particular purpose, and Fairview Microwave does not assume any liability arising out of the use of any part or documentation.

REVISIONS			
REV.	DESCRIPTION	DATE	APPROVED
A	INITIAL RELEASE	12/28/2022	SPONG

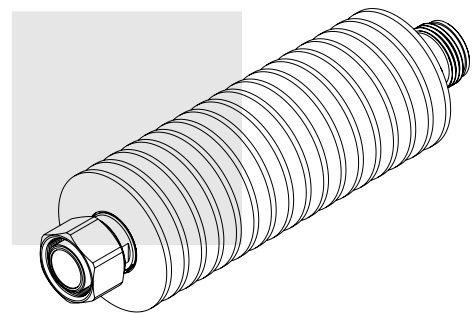
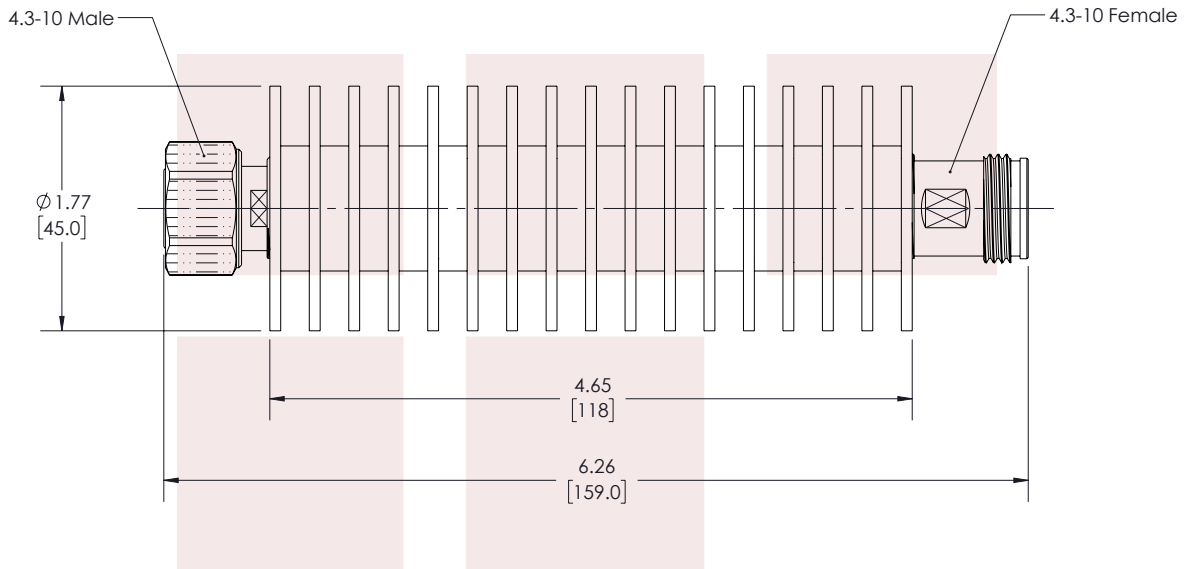

THESE COMMODITIES, TECHNOLOGY OR SOFTWARE WERE EXPORTED FROM THE UNITED STATES IN ACCORDANCE WITH THE EXPORT ADMINISTRATION REGULATIONS. DIVERSION CONTRARY TO U.S. LAW PROHIBITED.

TITLE

40 dB Fixed Attenuator, 4.3-10 Male (Plug) to 4.3-10 Female (Jack) Up to 6 GHz Rated to 100 Watts, 1.35:1 VSWR

UNLESS OTHERWISE SPECIFIED LEADING DIMENSIONS ARE INCHES
DIMENSIONS IN [] ARE MILLIMETERS

TOLERANCES:

.X = ±.2 [5.08] FRACTIONS ± 1/32

.XX = ±.02 [.51] ANGLES ± 1°

.XXX = ±.005 [.13]

CABLE LENGTH (L) TOLERANCES:

L ≤ 12 [305] = +1 [25] / -0

12 [305] < L ≤ 60 [1524] = +2 [51] / -0

60 [1524] < L ≤ 120 [3048] = +4 [102] / -0

120 [3048] < L ≤ 300 [7620] = +6 [152] / -0

300 [7620] < L = +5%L / -0

THIRD-ANGLE PROJECTION



THE INFORMATION AND DESIGN IN THIS DOCUMENT IS THE PROPERTY OF FAIRVIEW MICROWAVE CORPORATION. ALL RIGHTS RESERVED.

SHEET 1 OF 1

ALL DIMENSIONS SHOWN ARE FOR REFERENCE ONLY.

SCALE

N/A

SIZE A	CAGE CODE 3FKR5	DRAWN BY PSRINIVAS	ITEM NO. FMAT7453-40	REV A
-----------	--------------------	-----------------------	-------------------------	----------

T-Rev.D