

## 2.92mm Female (Jack) PCB Connector End Launch Microstrip/Coplanar Launch, Clamp/Solder (Captive Contact), 0.008 inch

2.92mm female connector with clamp/solder (captive contact) attachment for end launch PCB, part number FMCN1492, from Fairview Microwave is in-stock and ships same day. This 2.92mm female connector operates up to a maximum frequency of 40 GHz and offers excellent VSWR of 1.2:1.

Fairview's 2.92mm female connector FMCN1492 datasheet specifications and outline drawing are shown in this PDF below. Our extensive offering of RF, microwave and millimeter wave connectors allows designers to configure and customize their signal connections however they like. From providing an I/O for a board design to creating a custom cable assembly configuration, Fairview Microwave has a connector solution to meet your needs. Fairview Microwave also has the expertise to build your custom cable assemblies for you and ship them same-day.

### Electrical Specifications

Description	Min	Typ	Max	Units
Frequency Range	DC		40	GHz
VSWR			1.2:1	

#### Electrical Specification Notes:

Actual VSWR performance is largely dependent on circuit board design. For optimal results, the connector and circuit launch geometry should be modeled using Electromagnetic Simulation tools.

### Mechanical Specifications

#### Size

Length	0.561 in [14.25 mm]
Width/Dia.	0.469 in [11.91 mm]
Weight	0.01 lbs [4.54 g]
Mating Cycles	500 Cycles

### Material Specifications

Description	Material	Plating
Contact	Beryllium Copper	Gold
Insulation	PTFE	
Outer Conductor	Passivated Stainless Steel	
Body	Passivated Stainless Steel	

#### Mechanical Specification Notes:

Launch Pin is Gold Plated Beryllium Copper



### Configuration:

- 2.92mm Female Connector
- 50 Ohms
- Straight Body Geometry
- End Launch Interface Type
- Clamp/Solder (Captive Contact) Attachment

### Features:

- Operating Frequency of 40 GHz Max.
- Excellent VSWR of 1.2:1
- Gold Plated Beryllium Copper Contact
- Optimized for 8 mil RO4003C

### Applications:

- General Purpose Test
- PCB Applications
- Signal Integrity Measurement
- Chip Evaluations
- SERDES
- End Launch Test Fixtures
- Microstrip Launches
- CPW Launches

Fairview Microwave  
 301 Leora Ln., Suite 100  
 Lewisville, TX 75056  
 Tel: 1-800-715-4396 / (972) 649-6678  
 Fax: (972) 649-6689  
[www.fairviewmicrowave.com](http://www.fairviewmicrowave.com)  
[sales@fairviewmicrowave.com](mailto:sales@fairviewmicrowave.com)

**Environmental Specifications**

**Temperature**

Operating Range -40 to +125 deg C

**Compliance Certifications** (see [product page](#) for current document)

**Plotted and Other Data**

Notes:

**Assembly Instruction**

**STEP 1 :**  
Insert end launch connector (including ground block & screws) in the edge position of substrate.

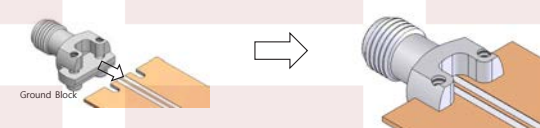

**STEP 2:**  
Tighten ground block against the substrate using two screws while ensuring flat pin is centered on the trace.

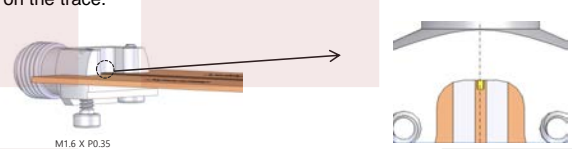

**STEP 3:**  
Solder the flat pin to center trace on substrate while the connector is held in the correct position.  
(Note: solder should flow along the length of the exposed flat pin for good electrical performance)

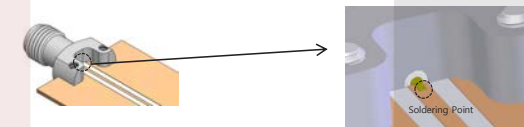

**STEP 4:**  
Remove any excess solder and clean all flux and other residues from the trace.

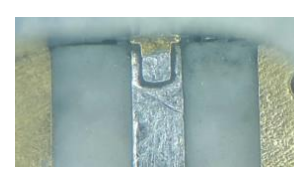

(Substrate shown for assembly instruction purposes only)

**TYPICAL PCB GEOMETRY**  
**SUBSTRATE THICKNESS: 0.008"**  
**MICROSTRIP WIDTH (A): 0.436mm**  
**SUBSTRATE MATERIAL: RO4003C**

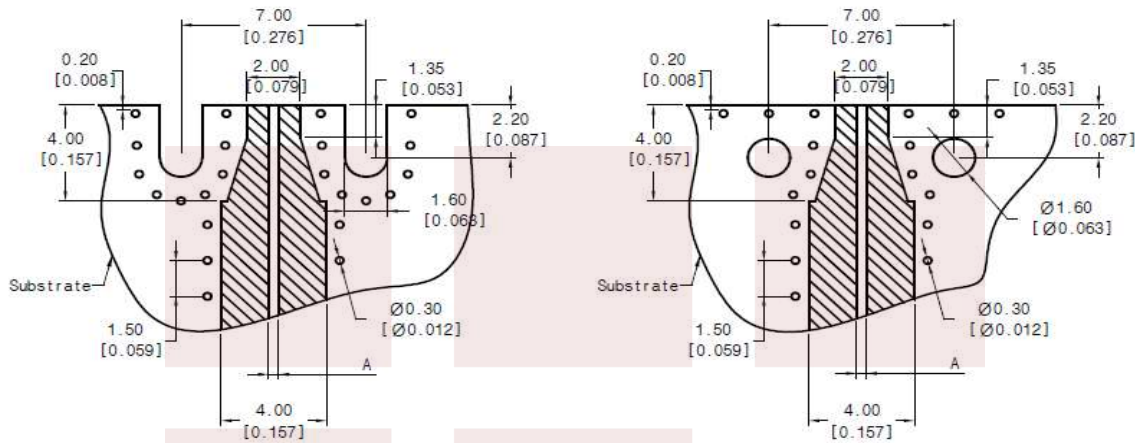

Dimensions shown in mm [inch]

**Typical Performance Data**

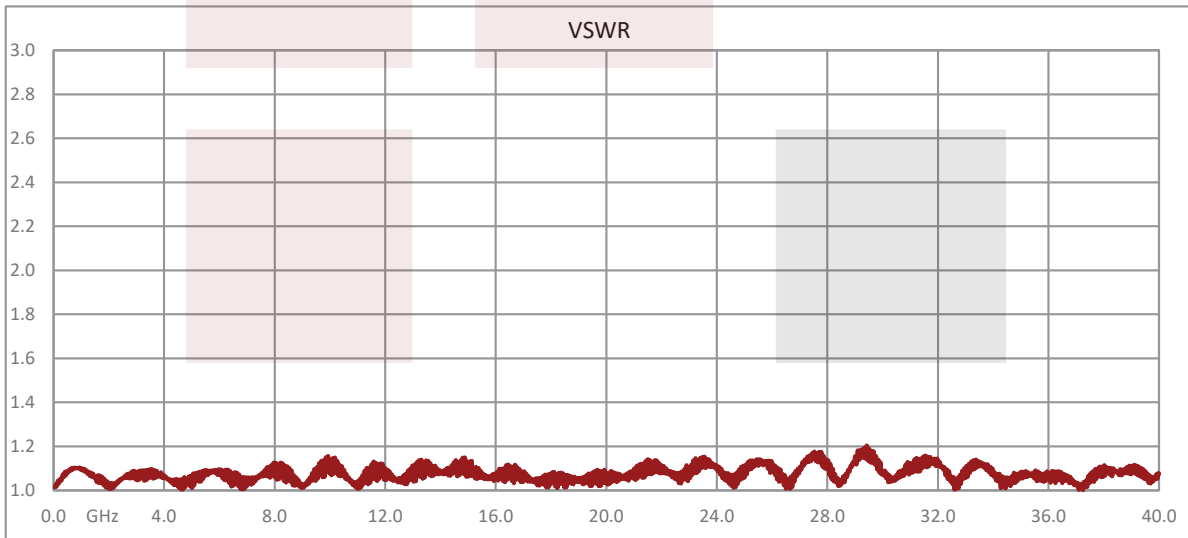

Test data taken with 2 connectors on both ends of test fixture

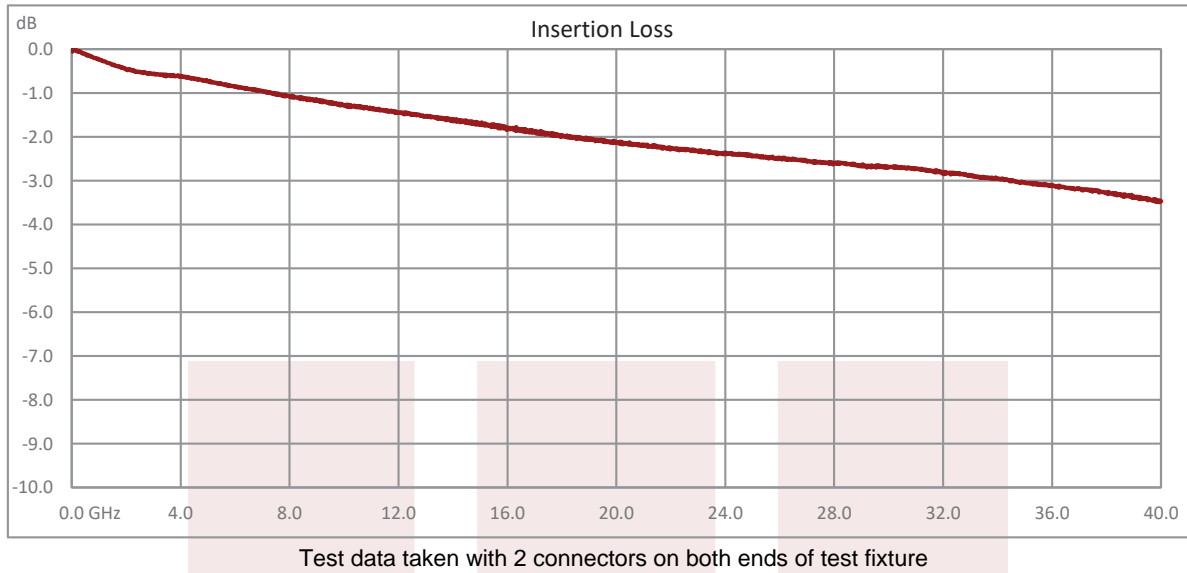

2.92mm Female (Jack) PCB Connector End Launch Microstrip/Coplanar Launch, Clamp/Solder (Captive Contact), 0.008 inch from Fairview Microwave is in-stock and available to ship same-day. All of our RF/microwave products are available off-the-shelf from our ISO 9001:2008 certified facilities in Lewisville, Texas. Fairview Microwave is RF on-demand.

For additional information on this product, please click the following link: [2.92mm Female \(Jack\) PCB Connector End Launch Microstrip/Coplanar Launch, Clamp/Solder \(Captive Contact\), 0.008 inch FMCN1492](https://www.fairviewmicrowave.com/2.92mm-female-end-launch-pcb-connector-fmcn1492-p.aspx)

URL: <https://www.fairviewmicrowave.com/2.92mm-female-end-launch-pcb-connector-fmcn1492-p.aspx>

The information contained in this document is accurate to the best of our knowledge and representative of the part described herein. It may be necessary to make modifications to the part and/or the documentation of the part, in order to implement improvements. Fairview Microwave reserves the right to make such changes as required. Unless otherwise stated, all specifications are nominal. Fairview Microwave does not make any representation or warranty regarding the suitability of the part described herein for any particular purpose, and Fairview Microwave does not assume any liability arising out of the use of any part or documentation.

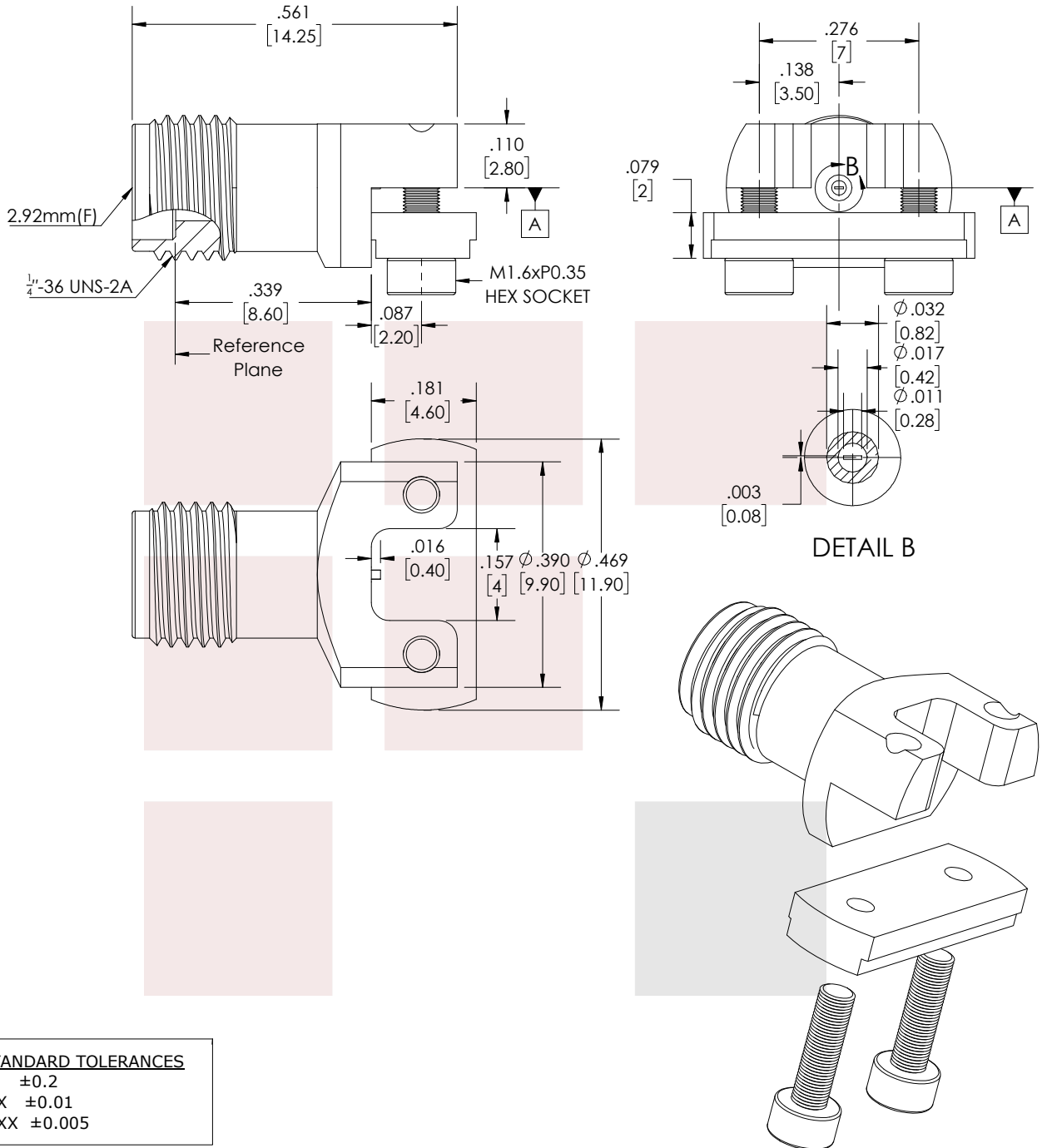

STANDARD TOLERANCES	
.X	±0.2
.XX	±0.01
.XXX	±0.005

\*STANDARD TOLERANCES APPLY ONLY TO DIMENSIONS IN INCHES

<b>FAIRVIEW MICROWAVE INC.</b> WWW.FAIRVIEWMICROWAVE.COM		NOTES: 1. UNLESS OTHERWISE SPECIFIED ALL DIMENSIONS ARE NOMINAL. 2. ALL SPECIFICATIONS ARE SUBJECT TO CHANGE WITHOUT NOTICE AT ANY TIME. 3. DIMENSIONS ARE IN INCHES [mm].	
TITLE 2.92mm Female (Jack) PCB Connector End Launch Microstrip/Coplanar Launch, Clamp/Solder (Captive Contact), 0.008 inch		DWG NO FMCN1492	CAGE CODE 3FKR5
CAD FILE 06/04/18	SHEET	SCALE N/A	SIZE A CN2379