

SMA Mixer from 5 MHz to 1.5 GHz with an IF Range from DC to 1 GHz and LO Power of +7 dBm

The FMMX1018 is a broadband Double Balanced Mixer that operates across an RF and LO frequency range from 5 MHz to 1500 MHz with an IF frequency range of DC to 1000 MHz and supports an LO drive level range from +3 to +10 dBm, with +7 dBm nominal. The design utilizes Schottky Ring Quad Diodes with optimized balun structures. Exceptional typical performance includes Conversion Loss of 7.5 dB, RF to LO and LO to IF isolation levels up to 50 dB, and an input IP3 level of +15 dBm. The 50 ohm hybrid module does not require any external components or matching circuitry. The rugged compact package assembly supports female SMA connectors, operates over a temperature range of -40°C to +85°C, and is designed to meet MIL-STD-202 environmental test conditions for Humidity, Shock, Vibration, and Altitude for high reliability.



Features:

- Broadband Double Balanced Mixer Design
- LO & RF Frequency Range: 5 MHz to 1500 MHz
- IF Frequency Range: DC to 1000 MHz
- LO Drive Level Range: +3 dBm to +10 dBm
- Schottky Ring Quad Diodes with Optimized Balun Structures
- Conversion Loss: 7.5 dB typ
- High Port Isolations up to 50 dB typ
- Input IP3 Level: +15 dBm
- RF Input Up to +1 dBm
- SMA Connectors
- Operating Temperature Range: -40°C to +85°C
- Designed to Meet MIL-STD-202 Environmental Test Conditions

Electrical Specifications

Description	Min	Typ	Max	Units
RF Frequency Range	0.005		1.5	GHz
LO Frequency Range	0.005		1.5	GHz
IF Frequency Range	DC		1,000	MHz
Impedance		50		Ohms
Conversion Loss		7.5	9.3	dB
LO to RF Isolation	23	40		dB
LO to IF Isolation	10	30		dB
RF Port VSWR		2:1	2.5:1	
IF Port VSWR		1.5:1	2:1	
Input at IP3	+12	+15		dBm
RF Input Power			+1	dBm
LO Input Power		+7		dBm

Applications:

- Electronic Warfare
- Point-to-Point Radios
- Point-to-Multipoint Radios
- VSAT
- Radar
- Space Systems
- Test Instrumentation

Mechanical Specifications

Weight 0.09 lbs [40.82 g]

Configuration

Design Double Balanced
 Package Type Connectorized
 RF Connector SMA Female
 LO Connector SMA Female
 IF Connector SMA Female

Environmental Specifications

Temperature

Operating Range -40 to +85 deg C
 Storage Range -55 to +100 deg C

Humidity MIL-STD-202F, Method 103B, Condition B

Fairview Microwave
 301 Leora Ln., Suite 100
 Lewisville, TX 75056
 Tel: 1-800-715-4396 / (972) 649-6678
 Fax: (972) 649-6689
www.fairviewmicrowave.com
sales@fairviewmicrowave.com

Shock
Vibration
Altitude

MIL-STD-202F, Method 213B, Condition B
MIL-STD-202F, Method 204D, Condition B
MIL-STD-202F, Method 105C, Condition B

Compliance Certifications (see [product page](#) for current document)

Plotted and Other Data

Notes:

Typical Performance Data

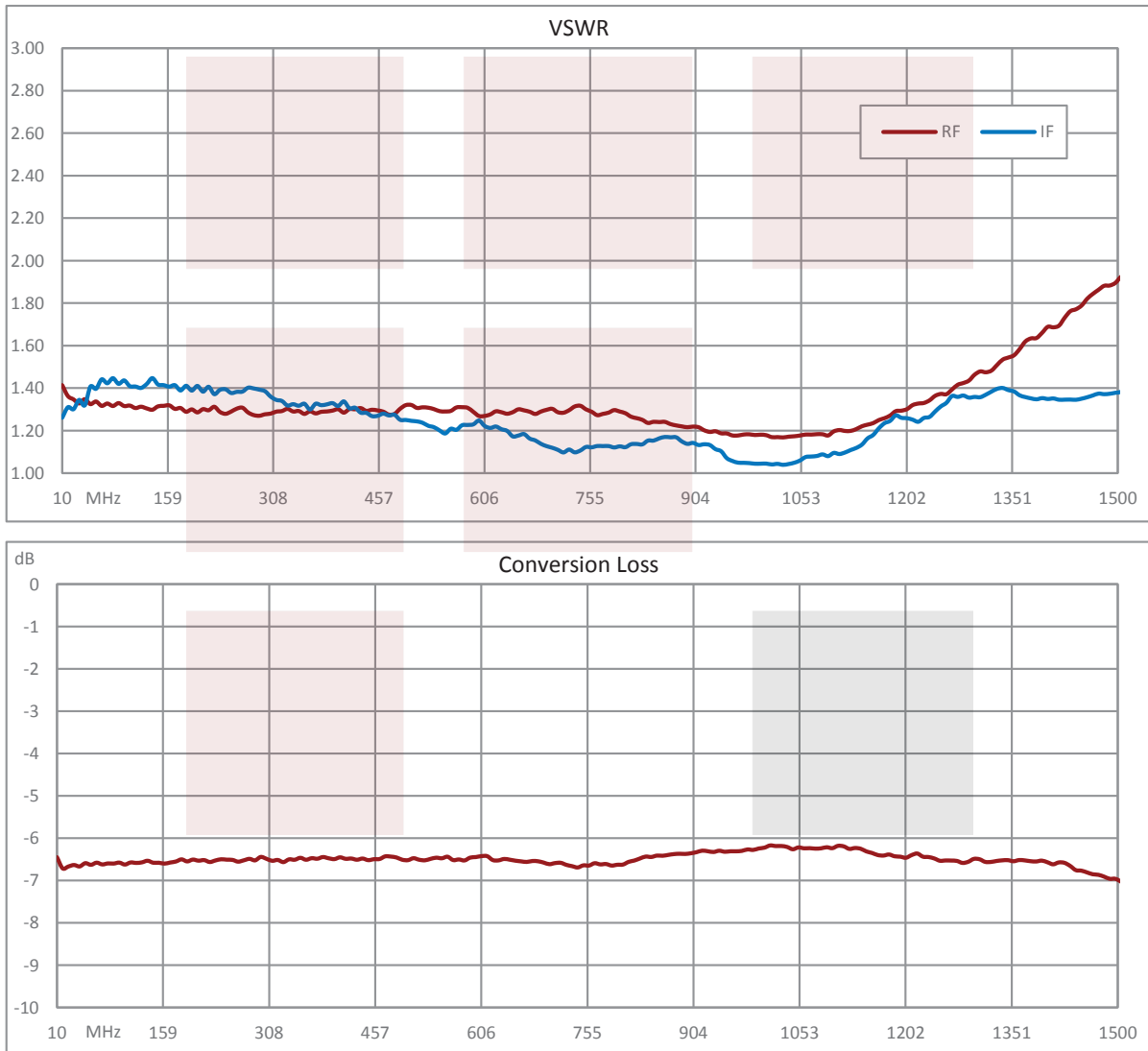

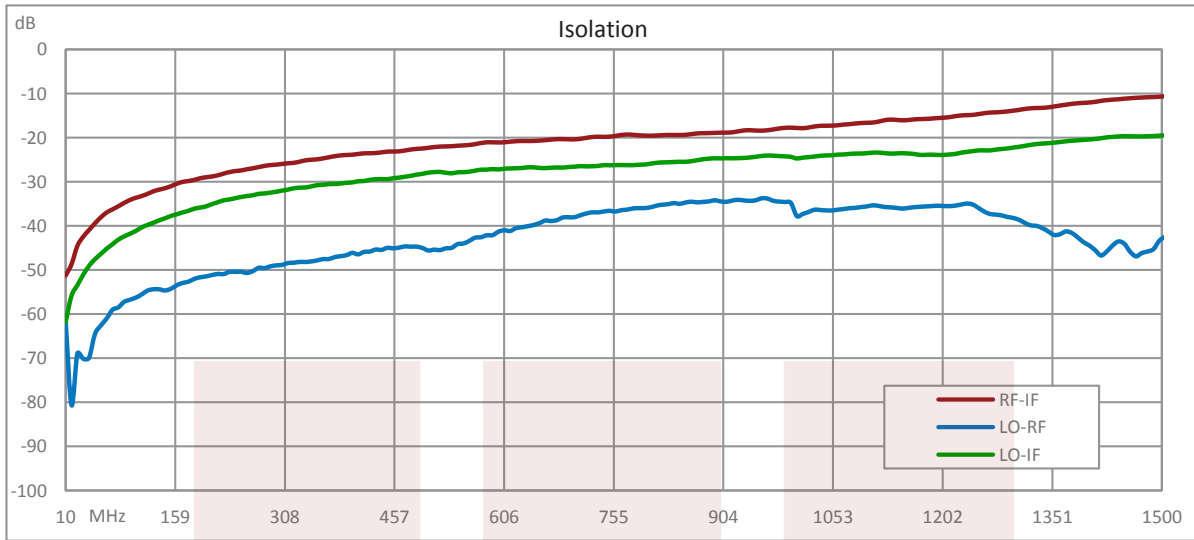

SMA Mixer from 5 MHz to 1.5 GHz with an IF Range from DC to 1 GHz and LO Power of +7 dBm from Fairview Microwave is in-stock and available to ship same-day. All of our RF/microwave products are available off-the-shelf from our ISO 9001:2008 certified facilities in Allen, Texas. Fairview Microwave is RF on-demand.

For additional information on this product, please click the following link: [SMA Mixer from 5 MHz to 1.5 GHz with an IF Range from DC to 1 GHz and LO Power of +7 dBm FMMX1018](https://www.fairviewmicrowave.com/sma-mixer-7-dbm-fmmx1018-p.aspx)

URL: <https://www.fairviewmicrowave.com/sma-mixer-7-dbm-fmmx1018-p.aspx>

The information contained in this document is accurate to the best of our knowledge and representative of the part described herein. It may be necessary to make modifications to the part and/or the documentation of the part, in order to implement improvements. Fairview Microwave reserves the right to make such changes as required. Unless otherwise stated, all specifications are nominal. Fairview Microwave does not make any representation or warranty regarding the suitability of the part described herein for any particular purpose, and Fairview Microwave does not assume any liability arising out of the use of any part or documentation.

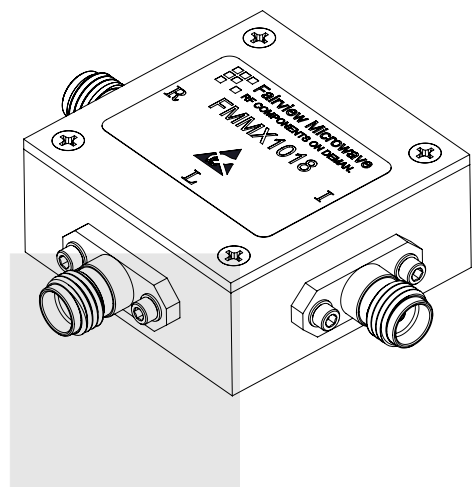
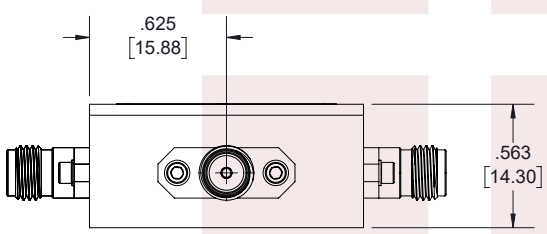
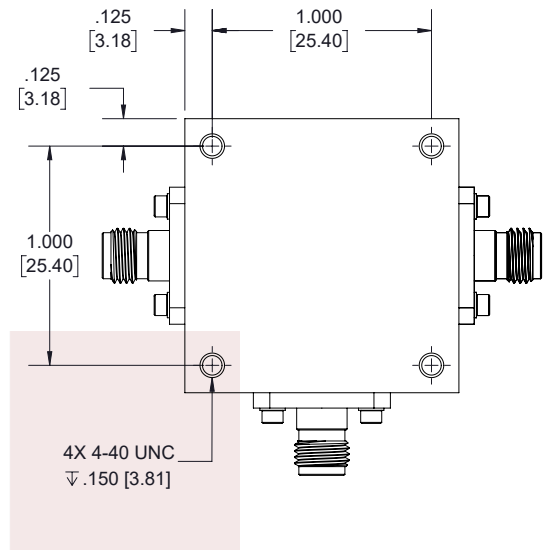
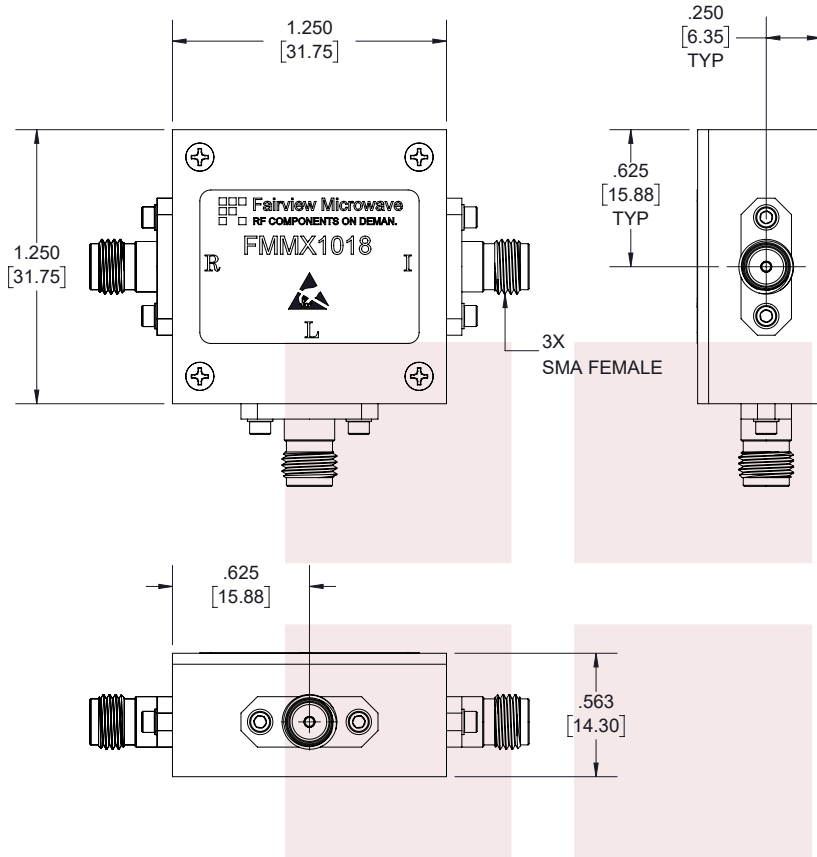

SCHEMATIC

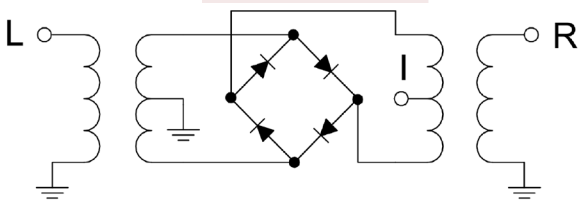

STANDARD TOLERANCES	
.X	±0.2
.XX	±0.01
.XXX	±0.005

*STANDARD TOLERANCES APPLY ONLY TO DIMENSIONS IN INCHES

Fairview Microwave RF COMPONENTS ON DEMAND. <i>Done!</i>		NOTES: 1. UNLESS OTHERWISE SPECIFIED ALL DIMENSIONS ARE NOMINAL. 2. ALL SPECIFICATIONS ARE SUBJECT TO CHANGE WITHOUT NOTICE AT ANY TIME. 3. DIMENSIONS ARE IN INCHES [mm].					
TITLE SMA Mixer from 5 MHz to 1.5 GHz with an IF Range from DC to 1 GHz and LO Power of +7 dBm		DWG NO FMMX1018			CAGE CODE 3FKR5		
		CAD FILE 04/26/18	SHEET 1 OF 1	SCALE N/A	SIZE A	7361	