

SPDT Latching DC to 18 GHz Electro-Mechanical Relay Switch, Hot Switching, up to 40W, 24V, 5M Lifecycles, SMT

The FMSW6416 is a single pole double throw electromechanical relay switch that operates from DC to 18 GHz. The design features a latching actuator with 2 coils and has a long and reliable lifespan up to 5M lifecycles typical (at low level) with excellent repeatability and thermal resistance. The innovative micro-mechanical design is in a miniature true surface mount package that's ideal for space limited applications. RF and command ports have gold plated access and the package can be mounted to a PWB using infrared reflow, forced air oven, or hand soldering processes. Impressive typical performance includes 0.4 dB insertion loss, 1.35:1 VSWR, and up to 50 dB isolation. Input power handling for hot switching is rated up to 40W, and operating voltage is +24 Vdc with 32 mA operating current. Performance is guaranteed over -40°C to +85°C and the switch assembly is RoHS and REACH compliant.

Electrical Specifications

Switch Type	SPDT
Actuator Type	Latching
Switching Sequence	Break Before Make
Actuator Options	Hot Switching

Description	Min	Typ	Max	Units
Frequency Range	DC		18	GHz
Impedance		50		Ohms
Operating Voltage	20.5	24	30	Volts
Actuating Set Current @ 24 Volts		32		mA
VSWR		1.4:1	1.7:1	
Insertion Loss		0.6	1	dB
Isolation	40			dB
Coil Resistance		865		Ohms
Third Order Intermodulation		-110		dBc
Input Power (CW)			3	Watts

Performance by Frequency

Description	F1	F2	F3	F4	F5	Units
Frequency Range	DC - 3	3 - 6	6 - 8	8 - 12.4	12.4 - 18	GHz
VSWR, Max	1.2:1	1.35:1	1.4:1	1.5:1	1.7:1	
Insertion Loss, Max	0.2	0.4	0.5	0.6	1	dB
Isolation, Min	50	40	40	40	40	dB
Power In, Typ (CW)	40	25	5	3	1	Watts



Features:

- Single Pole Double Throw SMT Relay Switch
- DC to 8 GHz Frequency Range
- 5M Cycle Typical Operating Life
- Up to 40W Average Power -Hot Switching
- -40°C to +85°C
- Insertion Loss 0.4 dB Typ
- VSWR 1.35:1 Typ
- +28Vdc @ 32 mA
- EAR99 Export Compliance
- RoHS & Reach Compliant

Applications:

- High Performance Relay Switch
- Instrumentation
- Modular Instrumentation
- Military Communications
- Communications Systems
- Test & Measurement
- ECM Equipment
- Tower Mount Amplifier
- Repeaters/Radio Links
- Remote Radio Unit (RRU)

Fairview Microwave
 301 Leora Ln., Suite 100
 Lewisville, TX 75056
 Tel: 1-800-715-4396 / (972) 649-6678
 Fax: (972) 649-6689
www.fairviewmicrowave.com
sales@fairviewmicrowave.com

Electrical Specification Notes:

Temperature: +23°C

Coil Resistance: +/-10%

Third Order Intermodulation @ 1730 MHz (2 carries 20W)

At high frequency, manual soldering may generate spikes and RF characteristics degradation, due to air gaps between PC board and relay grounds

RF and command ports		gold plated access, infrared reflow, forced air oven or hand soldering (Compatible with "lead free" soldering processes)	
Switching time (Nomial voltage)	Making contacts	Max 5ms, including contact bounce time	
	Breaking contacts	3ms	
Life	Cold switching (Max 120 cycles/min)	3 million cycles (5 million cycles typical at low level)	
	Hot switching (Max 20 cycles/min)	500.000 cycles (1W, impedance 50Ω , V.S.W.R. <1.25)	
Insulation		Dielectric test voltage	300Vrms
		Insulation resistance at 500Vdc	> 100MOhms
Environmental protection		"LEAD FREE » construction" Waterproofness according to IEC 60529 / IP64	
Mass		7.5g	
Operating temperature range (°C) (With no icing nor condensation)		-40 to +85	
Storage temperature range (°C)		-55 to +85	

Mechanical Specifications
Size

Length	0.59 in [14.99 mm]
Width/Diameter	0.5 in [12.7 mm]
Height	0.47 in [11.94 mm]
Weight	0.02255 lbs [10.23 g]
Package Type	Surface Mount
Operating Life	3,000,000 Cycles
Operating Life (Cold Switching)	5,000,000 Cycles
Operating Life (Hot Switching)	500,000 Cycles

Connectors

RF Connector Type	SMT
-------------------	-----

Environmental Specifications
Temperature

Operating Range	-40 to +85 deg C
Storage Range	-55 to +85 deg C

Shock	MIL STD 202, method 213B, Cond C
Vibration	MIL STD 202, method 204
Sine Vibration	MIL STD 202, method 204, Con D (Operating)/(Cond G (Non-Operating))

Compliance Certifications (see [product page](#) for current document)

Plotted and Other Data

Notes:

Diagram

Video shadow of the relay

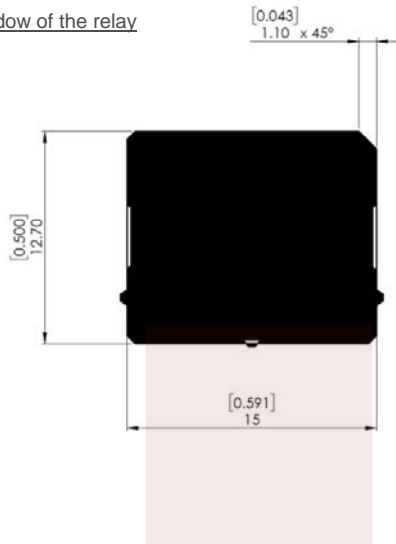

Aspiration area

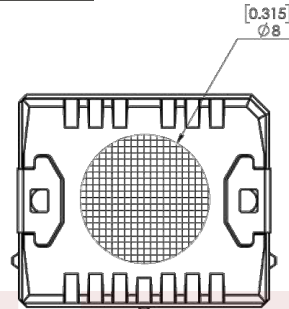

All dimensions are in millimeters [inches].

PC BOARD MOUNTING

Substrate Types

Recommended substrates are ROGERS RO4003.,
Thickness 0.508 mm Cu double side 17.5µm.
Recommended total thickness of RF tracks
(copper over thickness + plating) : 40µm.
Other substrates may be used

Board layout general outline

DXF or GERBER format file
available upon request

Relay soldering

DXF format file available upon request

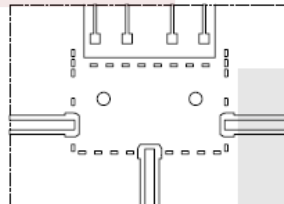

Optional fixing system : 2 screws M1.2

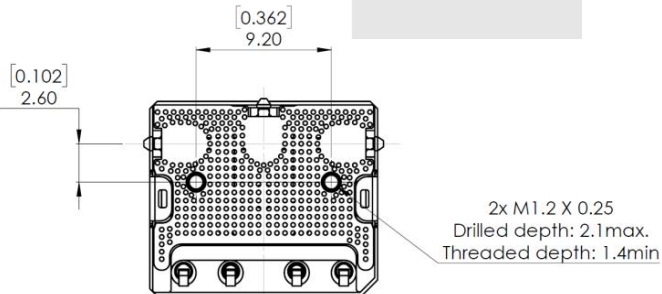

Typical Performance Data

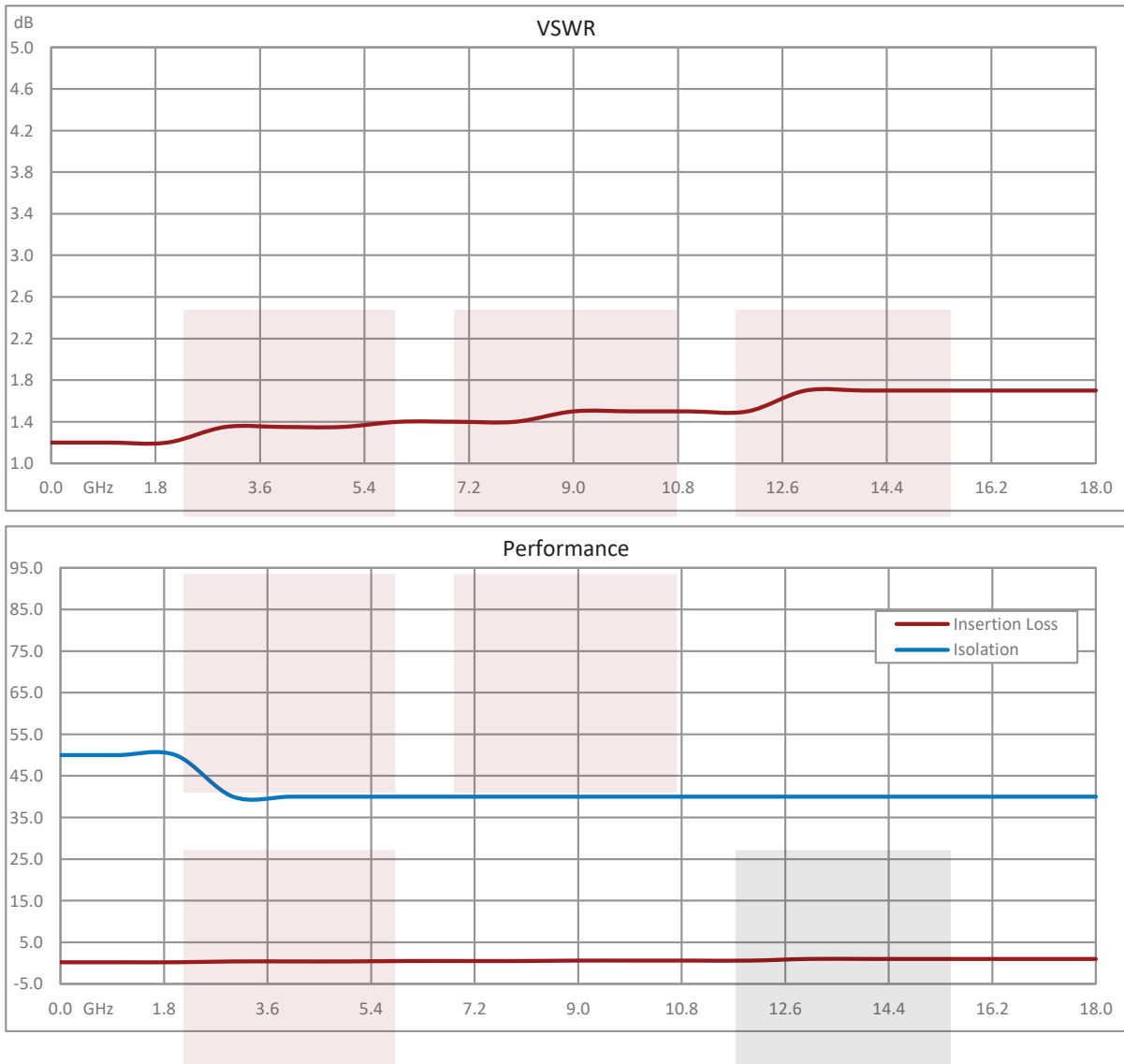

RF POWER RATING FOR COLD SWITCHING USE
(Impedance 50 Ohms, V.S.W.R. < 1.25)

Power level depends on environmental conditions :

The modules have been designed to be used without a cooling fan even for high power applications. However, the power capability may be still improved by using the appropriate cooling fan.

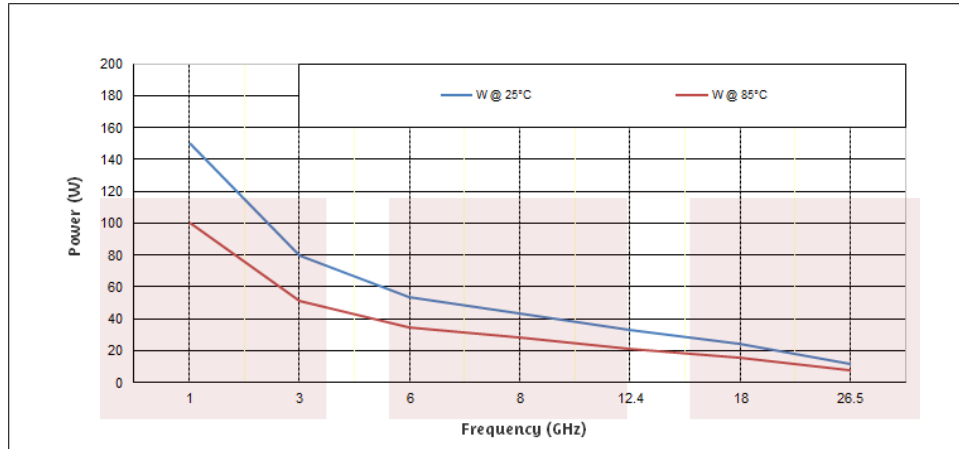

SPDT Latching DC to 18 GHz Electro-Mechanical Relay Switch, Hot Switching, up to 40W, 24V, 5M Lifecycles, SMT from Fairview Microwave is in-stock and available to ship same-day. All of our RF/microwave products are available off-the-shelf from our ISO 9001:2008 certified facilities in Lewisville, Texas. Fairview Microwave is RF on-demand.

For additional information on this product, please click the following link: [SPDT Latching DC to 18 GHz Electro-Mechanical Relay Switch, Hot Switching, up to 40W, 24V, 5M Lifecycles, SMT FMSW6416](https://www.fairviewmicrowave.com/spdt-latching-18-ghz-electro-mechanical-relay-switch-3w-24v-smt-fm-sw6416-p.aspx)

URL: <https://www.fairviewmicrowave.com/spdt-latching-18-ghz-electro-mechanical-relay-switch-3w-24v-smt-fm-sw6416-p.aspx>

The information contained in this document is accurate to the best of our knowledge and representative of the part described herein. It may be necessary to make modifications to the part and/or the documentation of the part, in order to implement improvements. Fairview Microwave reserves the right to make such changes as required. Unless otherwise stated, all specifications are nominal. Fairview Microwave does not make any representation or warranty regarding the suitability of the part described herein for any particular purpose, and Fairview Microwave does not assume any liability arising out of the use of any part or documentation.

REVISIONS			
REV.	DESCRIPTION	DATE	APPROVED
A	INITIAL RELEASE	9/22/2020	T.GALLA

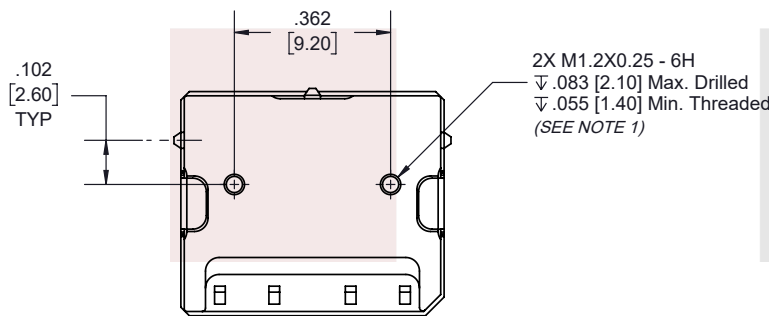
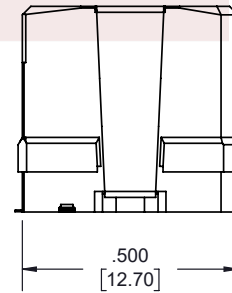
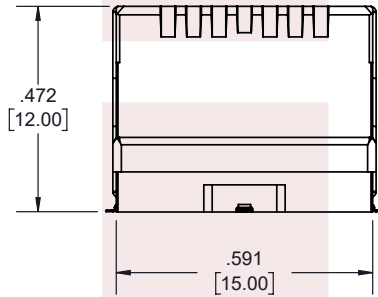
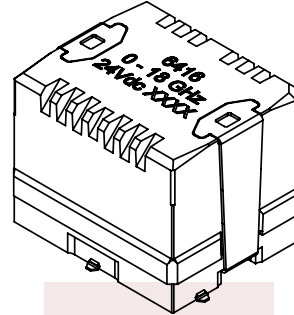
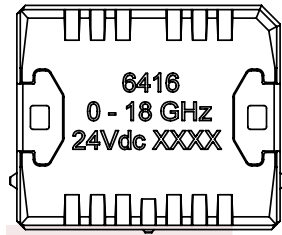

NOTES:

- OPTIONAL FIXING SYSTEM: 2 SCREWS M1.2
- DXF OR GERBER FORMAT FILE AVAILAIBLE UPON REQUEST.

THESE COMMODITIES, TECHNOLOGY OR SOFTWARE WERE EXPORTED FROM THE UNITED STATES IN ACCORDANCE WITH THE EXPORT ADMINISTRATION REGULATIONS. DIVERSION CONTRARY TO U.S. LAW PROHIBITED.

TITLE
SPDT Latching DC to 18 GHz Electro-Mechanical Relay Switch, Hot Switching, up to 40W, 24V, 5M Lifecycles, SMT

UNLESS OTHERWISE SPECIFIED LEADING DIMENSIONS ARE INCHES
DIMENSIONS IN [] ARE MILLIMETERS

TOLERANCES: CABLE LENGTH (L) TOLERANCES:

.X = ±.2 [5.08]	FRACTIONS	L ≤ 12 [305] = +1 [25] / -0
.XX = ±.02 [.51]	± 1/32	12 [305] < L ≤ 60 [1524] = +2 [51] / -0
.XXX = ±.005 [.13]	ANGLES ± 1°	60 [1524] < L ≤ 120 [3048] = +4 [102] / -0
		120 [3048] < L ≤ 300 [7620] = +6 [152] / -0
		300 [7620] < L = +5%L / -0

THIRD-ANGLE PROJECTION



THE INFORMATION AND DESIGN IN THIS DOCUMENT IS THE PROPERTY OF FAIRVIEW MICROWAVE CORPORATION. ALL RIGHTS RESERVED.

SHEET 1 OF 2

ALL DIMENSIONS SHOWN ARE FOR REFERENCE ONLY.

SCALE N/A

SIZE A	CAGE CODE 3FKR5	DRAWN BY K.DANG	ITEM NO. FMSW6416	REV A
-----------	--------------------	--------------------	----------------------	----------

T-Rev.D

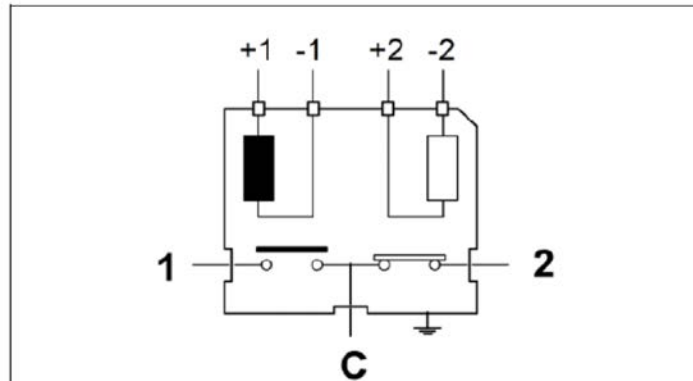

Latching model
(TYPE 3)

Voltage		RF Continuity
-1	+1	C ↔ 1
-2	+2	C ↔ 2

PIN IDENTIFICATION
(TOP VIEW)

THESE COMMODITIES, TECHNOLOGY OR SOFTWARE WERE EXPORTED FROM THE UNITED STATES IN ACCORDANCE WITH THE EXPORT ADMINISTRATION REGULATIONS. DIVERSION CONTRARY TO U.S. LAW PROHIBITED.

<p>Fairview Microwave an INFINIT[®] brand</p>	UNLESS OTHERWISE SPECIFIED LEADING DIMENSIONS ARE INCHES DIMENSIONS IN [] ARE MILLIMETERS		THIRD-ANGLE PROJECTION 		
	TOLERANCES:		CABLE LENGTH (L) TOLERANCES:		
TITLE SPDT Latching DC to 18 GHz Electro-Mechanical Relay Switch, Hot Switching, up to 40W, 24V, 5M Lifecycles, SMT	.X = ±.2 [.51] FRACTIONS ± 1/32 .XX = ±.02 [.51] ± 1/32 .XXX = ±.005 [.13] ANGLES ± 1°		L ≤ 12 [305] = +1 [25] / -0 12 [305] < L ≤ 60 [1524] = +2 [51] / -0 60 [1524] < L ≤ 120 [3048] = +4 [102] / -0 120 [3048] < L ≤ 300 [7620] = +6 [152] / -0 300 [7620] < L = +5%L / -0		THE INFORMATION AND DESIGN IN THIS DOCUMENT IS THE PROPERTY OF FAIRVIEW MICROWAVE CORPORATION. ALL RIGHTS RESERVED.
	ALL DIMENSIONS SHOWN ARE FOR REFERENCE ONLY.			SHEET 2 OF 2 SCALE N/A	
SIZE A	CAGE CODE 3FKR5	DRAWN BY K.DANG	ITEM NO. FMSW6416	REV A	

T-Rev.D

RECOMMENDED SOLDERING PROCEDURE

A – Soldering procedure using automatic pick and place equipment

1-Solder paste :

Pasternack recommends using a « no clean - low residue » solder cream (5% solid residue of flux quantity) that will permit the elimination of the cleaning operation step after soldering.
 Note : Due to the gold plating of the switch PCB interface, it is important to use a paste made with silver. This will help in avoiding formation of intermetallics as part of the solder joint.

2-Solder paste deposition :

Solder cream may be applied on the board with screen printing or dispenser technologies. For either method, the solder paste must be coated to appropriate thickness and shapes to achieve good solder wetting. Please optically verify that the edges of the zone are clean and without contaminates, and that the PCB zoned areas have not oxydated. The design of the mounting pads and the stenciling area are available upon request, for a thickness of the silk-screen printing of 0.15 mm (0.006").

3-Placement of the component :

For small lightweight components such as chip components, a self-alignment effect can be expected if small placement errors exist. However, this effect is not as expected for relays components and they require an accurate positioning on their soldering pads, typically +/- 0.1mm (+/-0.004"). Place the relay onto the PCB with automatic pick and place equipment. Various types of suction can be used. Pasternack does not recommend using adhesive agents on the component or on the PCB.

4-Soldering : infra-red process

Please follow the Pasternack recommended max temperature profile for infra-red reflow or forced air convection :

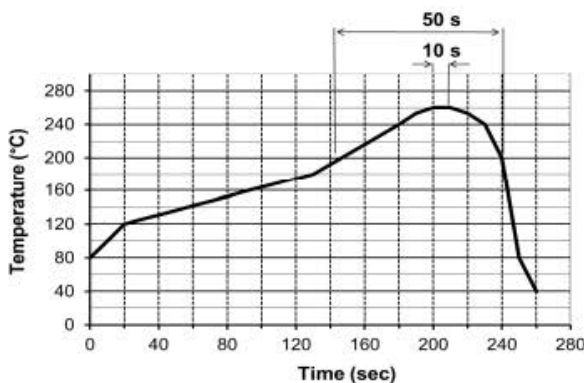

Higher temperature (>260°C) and longer process duration would damage permanently the switches.

SPDT Latching DC to 18 GHz Electro-Mechanical Relay Switch, Hot Switching, up to 40W, 24V, 5M Lifecycles, SMT

5-Cleaning procedure :

On miniature relays, high frequency cleaning may cause the contacts to stick. If cleaning is needed, please avoid ultrasonic cleaning and use alcohol based cleaning solutions.



In-line cleaning process, spraying, immersion, especially under temperature, may cause a risk of degradation of internal contacts. For such cleaning process please contact us.

6-Quality check :

Verify by visual inspection that the component is centred on the mounting pads.
 Solder joints : verify by visual inspection that the formation of meniscus on the pads are proper.

B – Soldering procedure by manual operation



: manual soldering is not recommended for high frequencies, as it generates resonance and lower RF characteristics due to gaps between PC board and relay grounds,.

1-Solder paste and flux deposition :

Refer to procedure A – 1
 Deposit a thin layer of flux on solder pad area. Allow the flux to evaporate a few seconds before applying the solder paste, it will prevent dilution of the paste.

2-Solder paste deposition :

Pasternack recommends depositing a small amount of solder paste on solder pad area by syringe, according to the manual soldering pattern (available upon request). Be careful, not to apply solder paste outside of the zone area.

3-Placement of the component :

During manipulation, avoid contaminating gold surfaces by contact with fingers.
 Place the component on the mounting zone by pressing on the top of the relay lid.

4-Hand soldering :

Iron wattage 30 to 60 W.
 To keep better RF characteristics, apply pressure on the relay lid during all the soldering stage, so as to reduce the air gap between the PC board and the relay.
 If possible, fix the ground plane of the relay on the board with two M1.2 screws before the soldering stage. On each side of the central RF access, the RF body edge must be soldered to the ground of the PC board. To improve RF characteristics and avoid soldering the RF body on the ground, a conductive gasket may be used (please contact us for detailed application note).

5-Cleaning procedure :

Refer to procedure A – 5.

6-Quality check:

Verify by visual inspection that component is centred on the mounting pads.
 Solder joints : verify by visual inspection that there is no solder excess on the RF pads.