

## WR-42 Standard Gain Horn Antenna Operating From 18 GHz to 26.5 GHz, 20 dBi Nominal Gain, UG-597/U Flange

The FMWAN042-20 standard gain horn antenna (also known as waveguide horn) from Fairview Microwave has a nominal gain of 20 dBi. The Fairview Microwave 20 dBi WR-42 horn antenna operates from 18 GHz to 26.5 GHz (K Band). This WR-42 standard gain horn has a UG-597/U type flange. Waveguide standard gain horn antennas are used in a wide variety of applications due to their high power handling capability, low loss, high directivity, and near constant electrical performance. These units are Aluminum and Powder coated for increased resistance to weather and corrosion with a Horizontal and Vertical Beam Width of 17.5 and 17.3 degrees respectively. Fairview Microwave's WR-42 standard gain horns are available in 10, 15 and 20 dBi models with pyramidal shape and rectangular input. K Band standard gain horn antenna can ship the same day to anywhere in the world. The WR-42 FMWAN042-20 waveguide horn is part of over 40,000 RF, microwave and millimeter wave components available from Fairview Microwave.

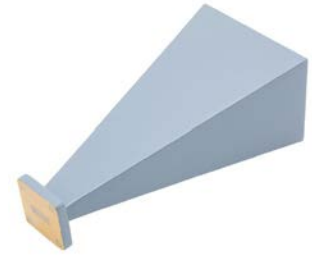

### Features:

- WR-42 Rectangular Waveguide Interface
- 18 GHz to 26.5 GHz
- 20 dBi Nominal Gain
- UG-597/U Cover Flange
- K Band

### Applications:

- Antenna Measurements
- Wireless Communication
- Laboratory Use
- Microwave Radio Systems

### Configuration

Design	WR-42
Polarization	Linear

### Electrical Specifications

Description	Min	Typ	Max	Units
Frequency Range	18		26.5	GHz
Nominal Gain		20		dB
Horizontal 3dB Beam Width		17.5		Deg
Vertical 3dB Beam Width		17.3		Deg
VSWR		1.3:1		

### Mechanical Specifications

#### Size

Length	4.331 in [110.01 mm]
Width/Diameter	2.054 in [52.17 mm]
Height	1.524 in [38.71 mm]
Weight	0.15 lbs [68.04 g]

#### Waveguide Interface

Waveguide Size	WR-42
Flange Type	Square Cover
Flange Designation	UG-597/U
Body Material and Plating	Aluminum, Gray

**Compliance Certifications** (see [product page](#) for current document)

### Plotted and Other Data

Notes:

Fairview Microwave  
301 Leora Ln., Suite 100  
Lewisville, TX 75056  
Tel: 1-800-715-4396 / (972) 649-6678  
Fax: (972) 649-6689  
[www.fairviewmicrowave.com](http://www.fairviewmicrowave.com)  
[sales@fairviewmicrowave.com](mailto:sales@fairviewmicrowave.com)

**Typical Performance Data**

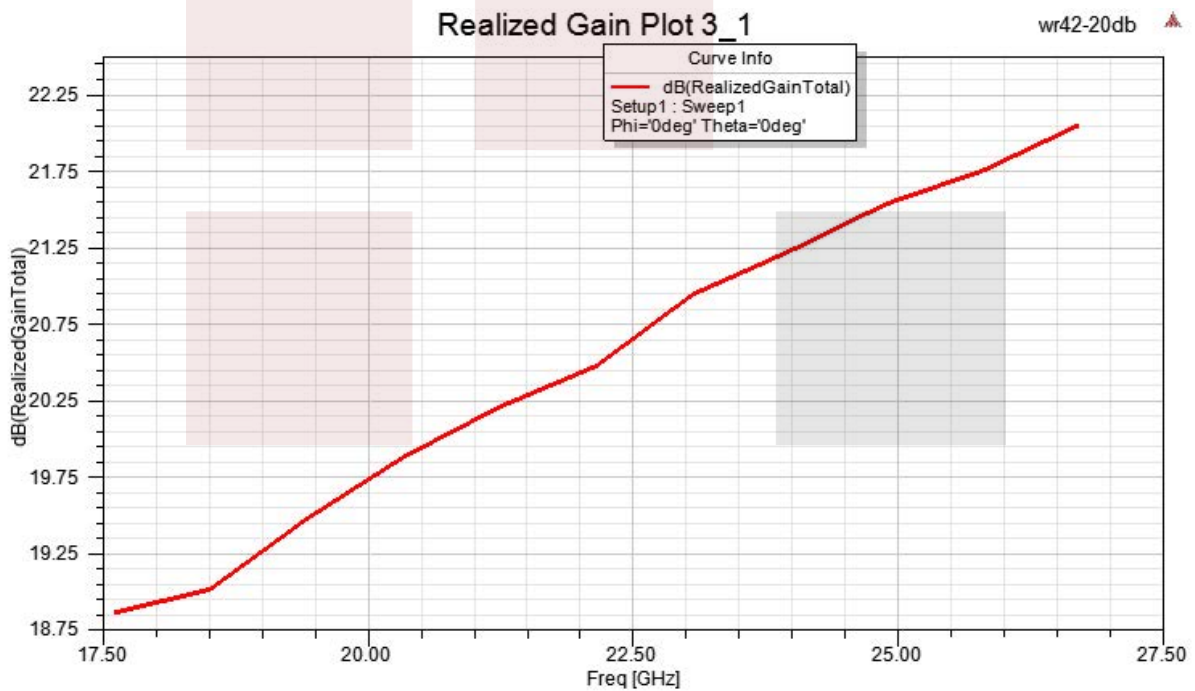
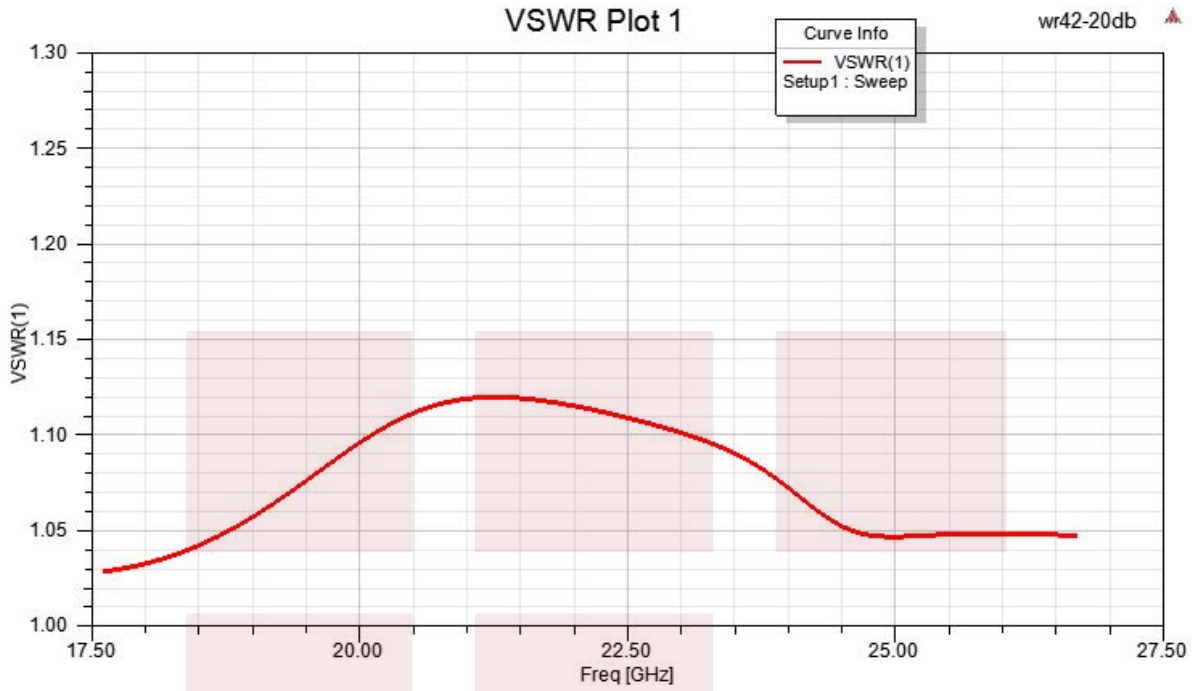

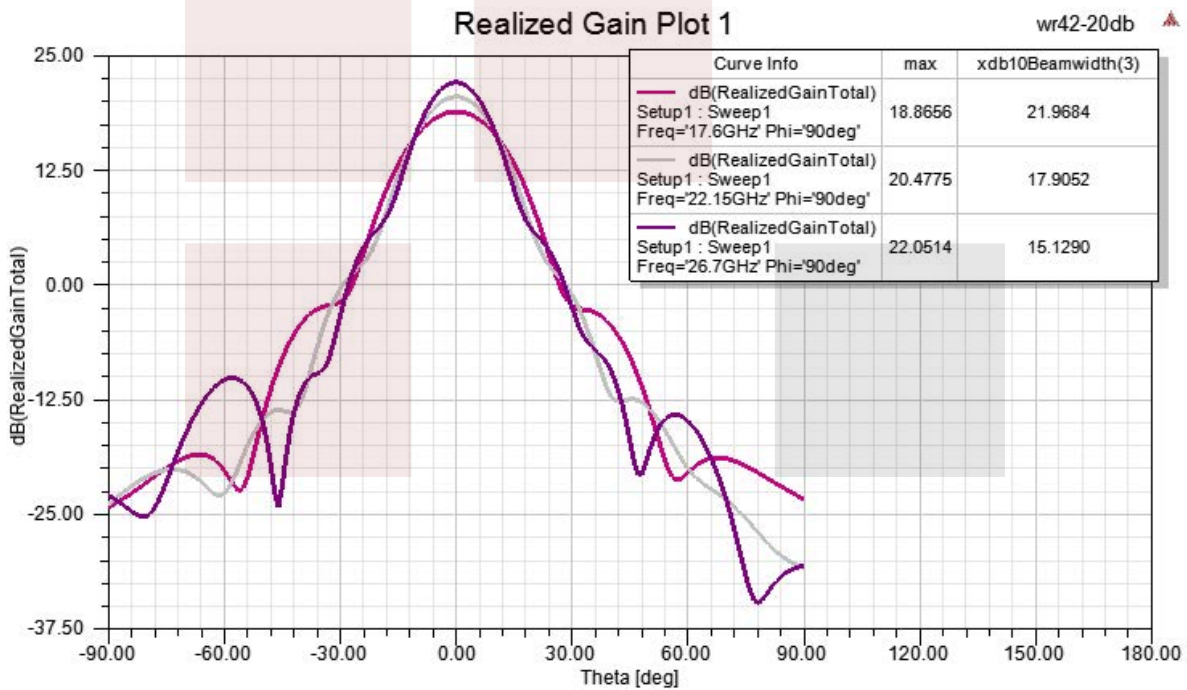
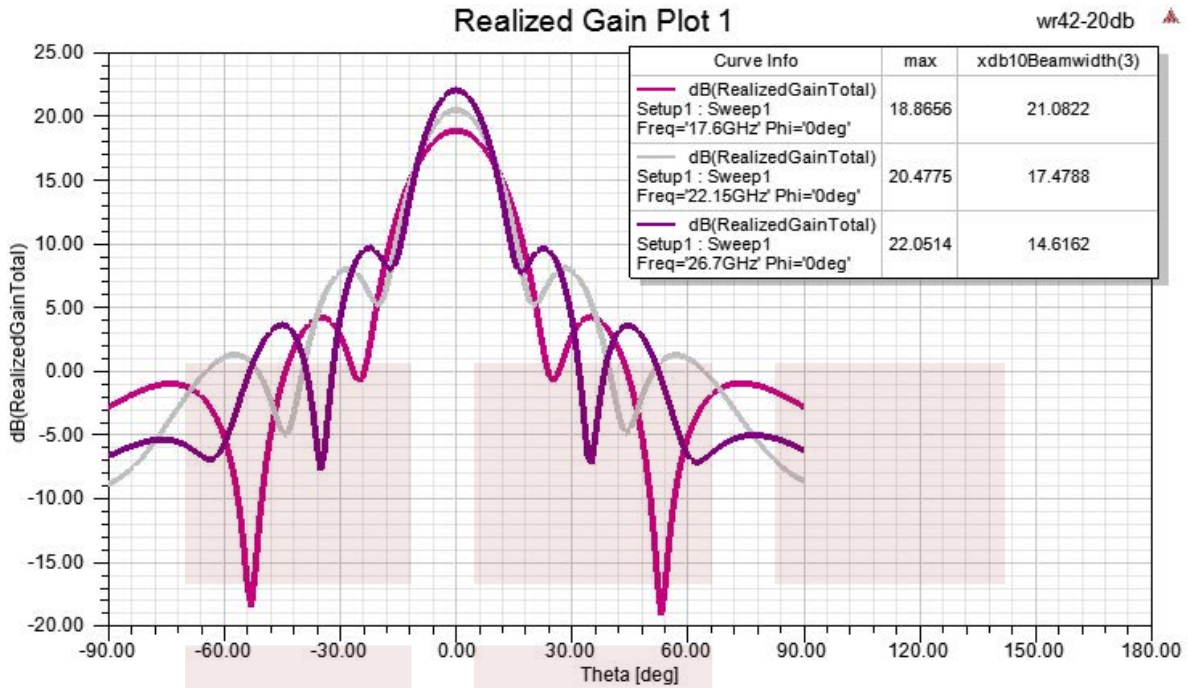

WR-42 Standard Gain Horn Antenna Operating From 18 GHz to 26.5 GHz, 20 dBi Nominal Gain, UG-597/U Flange from Fairview Microwave is in-stock and available to ship same-day. All of our RF/microwave products are available off-the-shelf from our ISO 9001:2008 certified facilities in Lewisville, Texas. Fairview Microwave is RF on-demand.

For additional information on this product, please click the following link: [WR-42 Standard Gain Horn Antenna Operating From 18 GHz to 26.5 GHz, 20 dBi Nominal Gain, UG-597/U Flange FMWAN042-20](#)

URL:

The information contained in this document is accurate to the best of our knowledge and representative of the part described herein. It may be necessary to make modifications to the part and/or the documentation of the part, in order to implement improvements. Fairview Microwave reserves the right to make such changes as required. Unless otherwise stated, all specifications are nominal. Fairview Microwave does not make any representation or warranty regarding the suitability of the part described herein for any particular purpose, and Fairview Microwave does not assume any liability arising out of the use of any part or documentation.



REVISIONS			
REV.	DESCRIPTION	DATE	APPROVED
A	INITIAL RELEASE	06/14/2021	KHIETPAS

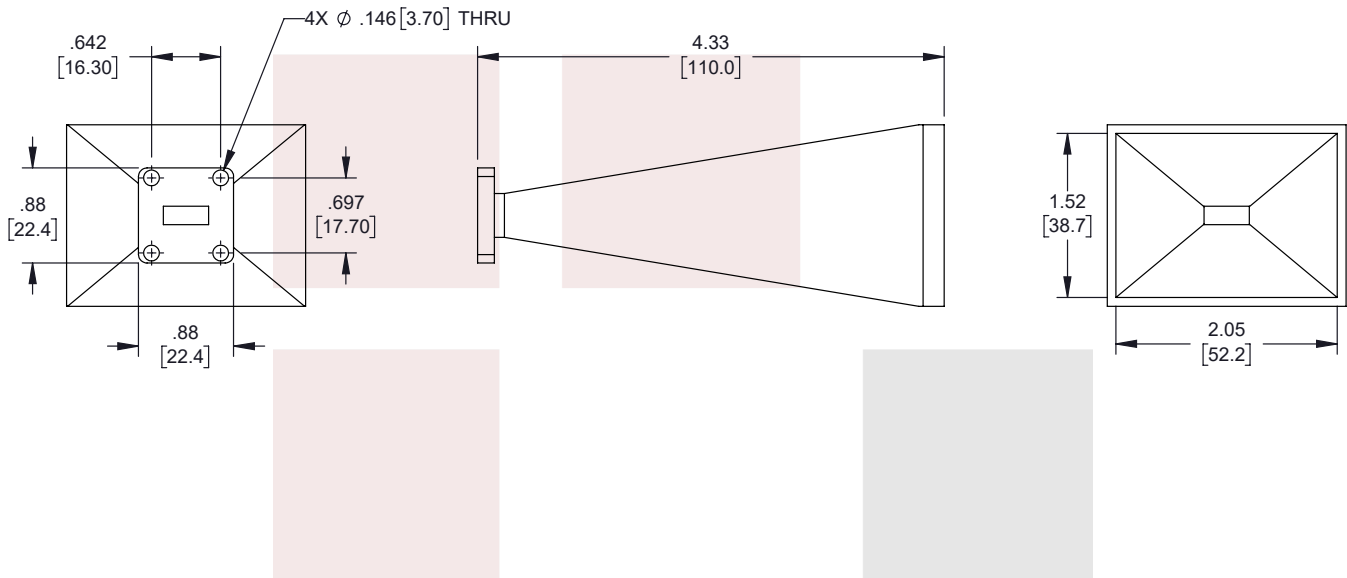
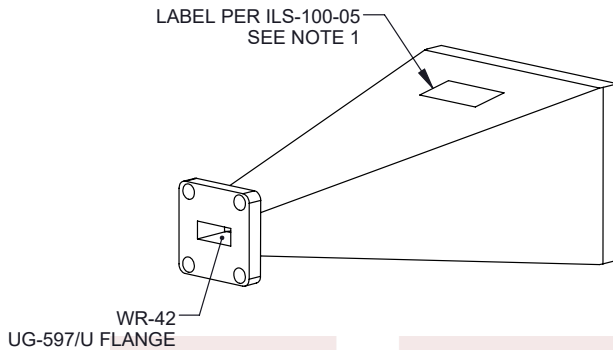

**NOTES:**

1. LABEL PER ILS-100-05 (FOR INTERNAL REFERENCE ONLY)  
LABEL LOCATION FOR REFERENCE ONLY

THESE COMMODITIES, TECHNOLOGY OR SOFTWARE WERE EXPORTED FROM THE UNITED STATES IN ACCORDANCE WITH THE EXPORT ADMINISTRATION REGULATIONS. DIVERSION CONTRARY TO U.S. LAW PROHIBITED.

TITLE  
WR-42 Standard Gain Horn Antenna Operating From 18 GHz to 26.5 GHz, 20 dBi Nominal Gain, UG-597/U Flange

UNLESS OTHERWISE SPECIFIED LEADING DIMENSIONS ARE INCHES  
DIMENSIONS IN [ ] ARE MILLIMETERS

TOLERANCES: CABLE LENGTH (L) TOLERANCES:

.X = ±.2 [5.08]	FRACTIONS	L ≤ 12 [305] = +1 [25] / -0
.XX = ±.02 [.51]	± 1/32	12 [305] < L ≤ 60 [1524] = +2 [51] / -0
.XXX = ±.005 [.13]	ANGLES ± 1°	60 [1524] < L ≤ 120 [3048] = +4 [102] / -0
		120 [3048] < L ≤ 300 [7620] = +6 [152] / -0
		300 [7620] < L = +5%L / -0

THIRD-ANGLE PROJECTION



THE INFORMATION AND DESIGN IN THIS DOCUMENT IS THE PROPERTY OF FAIRVIEW MICROWAVE CORPORATION. ALL RIGHTS RESERVED.

SHEET 1 OF 1

ALL DIMENSIONS SHOWN ARE FOR REFERENCE ONLY.

SCALE N/A

SIZE A	CAGE CODE 3FKR5	DRAWN BY DZINN	ITEM NO. FMWAN042-20	REV A
-----------	--------------------	-------------------	-------------------------	----------

T-Rev.D