

M39012/79-3007 SMA Male (Plug) Connector For RG405 Cable, Solder

SMA male connector with solder/solder attachment for RG405, part number M39012/79-3007, from Fairview Microwave is in-stock and ships same day. This SMA male connector operates up to a maximum frequency of 18 GHz and offers excellent VSWR of 1.25:1.

Fairview's SMA male connector M39012/79-3007 datasheet specifications and outline drawing are shown in this PDF below. Our extensive offering of RF, microwave and millimeter wave connectors allows designers to configure and customize their signal connections however they like. From providing an I/O for a board design to creating a custom cable assembly configuration, Fairview Microwave has a connector solution to meet your needs. Fairview Microwave also has the expertise to build your custom cable assemblies for you and ship them same-day.

Electrical Specifications

Description	Min	Typ	Max	Units
Frequency Range	DC		18	GHz
VSWR			1.25:1	
DWV (AC)			1,000	Vrms

Mechanical Specifications

Size	
Length	0 in [0 mm]
Width/Dia.	0 in [0.00 mm]
Height	0 in [0 mm]
Weight	0.0065 lbs [2.95 g]

Material Specifications

Description	Material	Plating
Contact	Beryllium Copper	Gold
Insulation	PTFE	
Outer Conductor	Stainless Steel	Gold
Body	Stainless Steel	Gold
Coupling Nut	Stainless Steel	

Compliance Certifications (see [product page](#) for current document)

Plotted and Other Data

Notes:



Configuration:

- SMA Male Connector
- 50 Ohms
- Straight Body Geometry
- RG405 Interface Type
- Solder/Solder Attachment
- 5/16 inch Hex

Features:

- Operating Frequency of 18 GHz Max.
- Excellent VSWR of 1.25:1
- Gold Plated Beryllium Copper Contact

Applications:

- General Purpose Test
- Custom Cable Assemblies

Fairview Microwave
 301 Leora Ln., Suite 100
 Lewisville, TX 75056
 Tel: 1-800-715-4396 / (972) 649-6678
 Fax: (972) 649-6689
www.fairviewmicrowave.com
sales@fairviewmicrowave.com

M39012/79-3007 SMA Male (Plug) Connector For RG405 Cable, Solder from Fairview Microwave is in-stock and available to ship same-day. All of our RF/microwave products are available off-the-shelf from our ISO 9001:2008 certified facilities in Lewisville, Texas. Fairview Microwave is RF on-demand.

For additional information on this product, please click the following link: [M39012/79-3007 SMA Male \(Plug\) Connector For RG405 Cable, Solder M39012/79-3007](#)

URL: <https://www.fairviewmicrowave.com/sma-male-rg405-connector-m39012-79-3007-p.aspx>

The information contained in this document is accurate to the best of our knowledge and representative of the part described herein. It may be necessary to make modifications to the part and/or the documentation of the part, in order to implement improvements. Fairview Microwave reserves the right to make such changes as required. Unless otherwise stated, all specifications are nominal. Fairview Microwave does not make any representation or warranty regarding the suitability of the part described herein for any particular purpose, and Fairview Microwave does not assume any liability arising out of the use of any part or documentation.



REVISIONS			
REV.	DESCRIPTION	DATE	APPROVED
A	INITIAL RELEASE	10/11/2021	A. GANWANI

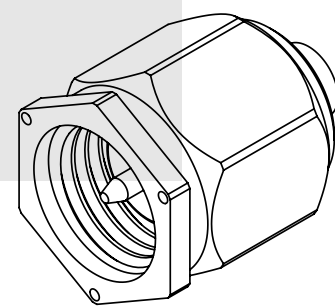
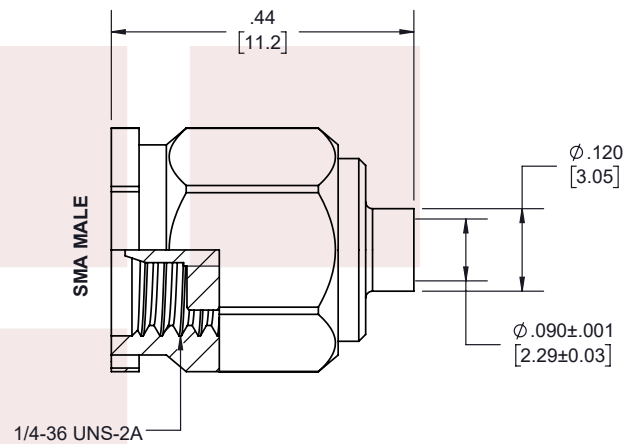
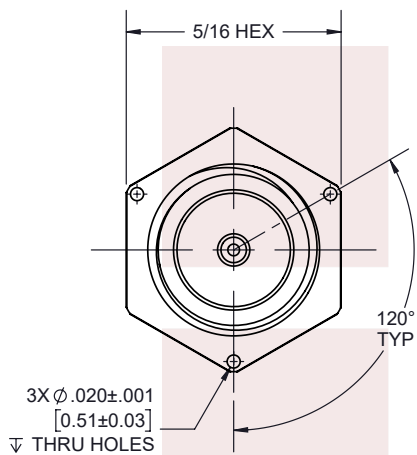

THESE COMMODITIES, TECHNOLOGY OR SOFTWARE WERE EXPORTED FROM THE UNITED STATES IN ACCORDANCE WITH THE EXPORT ADMINISTRATION REGULATIONS. DIVERSION CONTRARY TO U.S. LAW PROHIBITED.

TITLE
M39012/79-3007 SMA Male (Plug) Connector For RG405 Cable, Solder

UNLESS OTHERWISE SPECIFIED LEADING DIMENSIONS ARE INCHES DIMENSIONS IN [] ARE MILLIMETERS		THIRD-ANGLE PROJECTION	
TOLERANCES:		CABLE LENGTH (L) TOLERANCES:	
.X ± .2 [.508]	FRACTIONS ± 1/32	L ≤ 12 [305] = +1 [25] / -0	<p>THE INFORMATION AND DESIGN IN THIS DOCUMENT IS THE PROPERTY OF FAIRVIEW MICROWAVE CORPORATION. ALL RIGHTS RESERVED.</p>
.XX ± .02 [.51]	ANGLES ± 1°	12 [305] < L ≤ 60 [1524] = +2 [51] / -0	
.XXX ± .005 [.13]		60 [1524] < L ≤ 120 [3048] = +4 [102] / -0	
		120 [3048] < L ≤ 300 [7620] = +6 [152] / -0 300 [7620] < L = +5%L / -0	
ALL DIMENSIONS SHOWN ARE FOR REFERENCE ONLY.			
SIZE A	CAGE CODE 3FKR5	DRAWN BY K.DANG	ITEM NO. M39012/79-3007
SHEET 1 OF 1			SCALE N/A
REV A			

T-Rev.D