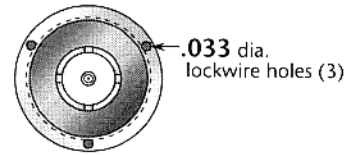
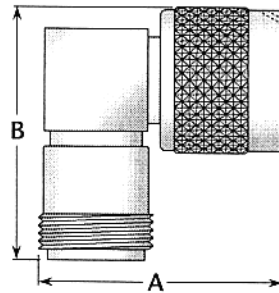
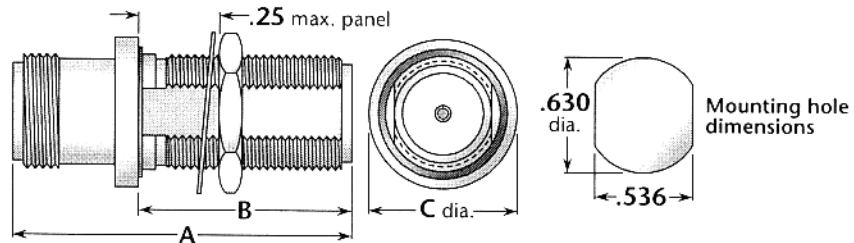


## M55339—N Adapters Within Series

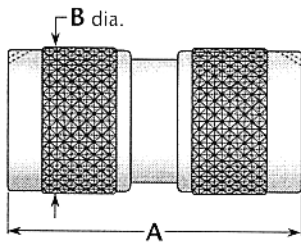
**Figure 1  
(Right angle jack-plug)**



**Coupling nut detail  
(For figures 1, 3, and 4)**

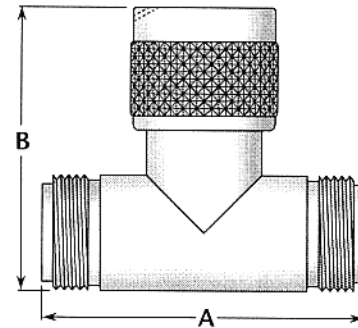


**Figure 2 (Bulkhead mounted jack-jack, hermetically sealed)**

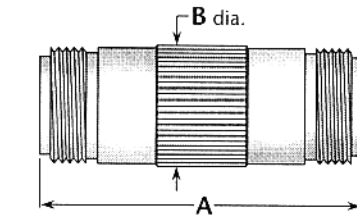
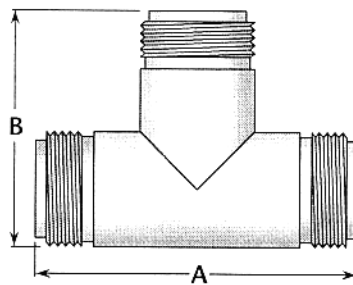


**Figure 3  
(Straight plug-plug)**

**Figure 4  
(Tee, jack-plug-jack)**



**Figure 5  
(Tee, jack-jack-jack)**



**Figure 6 (Straight jack-jack)**

M55339 P/N	Figure	Dimensions			Plating	
		A	B	C	Body	Contact
M55339/03-00027	1	1.30	1.38	—	Silver	Gold (C)
M55339/04-00030	2	1.54	.86	.875	Silver	Gold (C)
M55339/05-00057	3	1.59	—	—	Silver	Gold (C)
M55339/06-00001	4	1.75	1.47	—	Silver	Gold (C)
M55339/06-00028	5	1.75	1.22	—	Silver	Gold (C)
M55339/07-00029	6	1.75	.66	—	Silver	Gold (C)