

STANDARD GAIN HORN 10 dB GAIN WR284

SH1284-10

SPECIFICATIONS

ELECTRICAL:

FREQUENCY: 2.6 - 3.95 GHZ
 TYPICAL GAIN VARIATION: ± 1.5 TO ± 2.0 DB
 GAIN*: 10 DB
 3 DB BEAM WIDTH*:
 E PLANE: 50.8°
 H PLANE: 54.1°

MATERIALS:

BODY/FLANGE: ALUMINIUM
 FINISH: UNIQUE CORROSION RESISTANT
 316 STAINLESS STEEL EPOXY COATING IAW MIL-F-14072
 FLANGE: MIL-SPEC COVER FLANGE: UG-584/U

*GAIN & 3 DB BEAM WIDTH VALUES ARE
 CALCULATED BY COMPUTER SIMULATION

MEASUREMENTS BELOW ARE TYPICAL

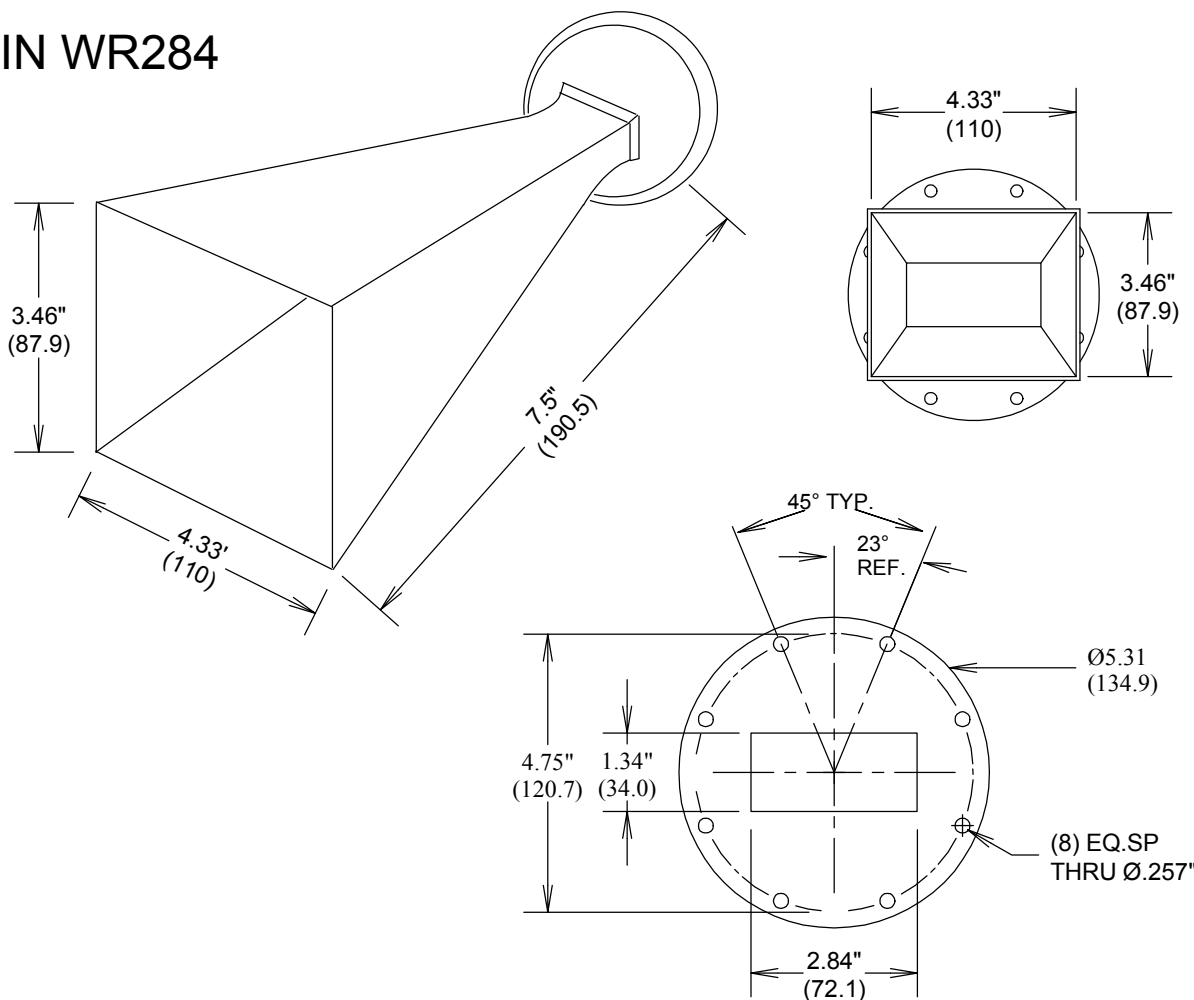
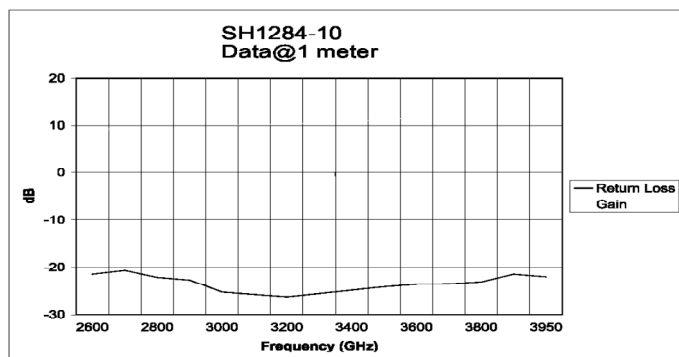

FAIRVIEW MICROWAVE INC.

ALLEN, TX 75013 WWW.FAIRVIEWMICROWAVE.COM

TITLE

STANDARD GAIN HORN 10 dB GAIN WR284

SIZE	CAGE CODE	DWG NO	REV
A	3FKR5	SH1284-10	--
SCALE	SHEET		

ALL DIMENSIONS IN inches(mm) Typical