

WR-112 Waveguide Standard Gain Horn Antenna Operating from 7.05 GHz to 10 GHz with a Nominal 15 dBi Gain with CPRG Flange

Waveguide horn antennas FM9858B-15-CPRG from Fairview Microwave is just one part in a large selection of our waveguide components. Fairview TAA Complaint waveguide horn antenna is manufactured with a WR-112 / R-84 / WG-15 waveguide size. Our WR-112 / R-84 / WG-15 waveguide horn antenna is constructed with a CPR-112G flange and built to precise RF wave waveguide horn antenna design specifications.

Fairview Microwave's WR-112 / R-84 / WG-15 waveguide antenna with CPR-112G flange from Fairview Microwave is a 15 dBi gain and in-stock now. Our WR-112 / R-84 / WG-15, 15 dBi gain horn antenna has a minimum frequency of 7.05 (GHz) and a maximum frequency of 10 (GHz). This waveguide WR-112 / R-84 / WG-15 horn antenna is TAA complaint, which can be used for government and military purpose. FM9858B-15-CPRG horn antenna flange has EIA / IEC / UK designation WR-112 / R-84 / WG-15 respectively. This Antenna is ideal for measurement standard and calibration application. The Grooved design in CPR flange allows for tight pressurized fitting with no leaks.

Additional specs on this Waveguide horn with WR-112 / R-84 / WG-15 can be found on the datasheet specifications above. This Waveguide antenna is part of over one million RF, microwave, and millimeter wave components in stock. Our part number FM9858B-15-CPRG Wave guide horn antenna is ready for same day purchase and shipping worldwide. Fairview also stocks a wide array of other waveguide products that ship same-day from our Lewisville, TX United States warehouse for all your RF/microwave and millimeter wave waveguide component needs.

Configuration

Design	WR-112 Standard Gain Horn
Pattern	Directional
Polarization	Linear

Electrical Specifications

Description	Min	Typ	Max	Units
Frequency Range	7.05		10	GHz
Nominal Gain		15		dBi
VSWR		1.5:1		

Mechanical Specifications

Size

Length	2.87 in [72.9 mm]
Width/Diameter	2.11 in [53.59 mm]
Height	4.9 in [124.46 mm]
Weight	0.148 lbs [67.13 g]

Waveguide Interface

Waveguide Size	WR-112
Flange Type	CPRG
Body Material and Plating	Aluminum



Features:

- WR-112 / R-84 / WG-15 Rectangular waveguide interface with 15 dBi Nominal Gain
- 7.05 GHz to 10 GHz Frequency range
- CPR-G (Grooved) flange
- Made from high-grade aluminum with corrosion resistant powder coating
- Consistent gain versus frequency
- TAA Compliant waveguides

Applications:

- TAA Compliant waveguides (Made in USA)
- Typical low VSWR < 1.5
- Antenna measurements
- Microwave Radio systems solutions
- Wireless communications
- Radome, Automotive antenna, Satellite antenna testing
- Laboratory use

Fairview Microwave
301 Leora Ln., Suite 100
Lewisville, TX 75056
Tel: 1-800-715-4396 / (972) 649-6678
Fax: (972) 649-6689
www.fairviewmicrowave.com
sales@fairviewmicrowave.com

z

Compliance Certifications (see [product page](#) for current document)

Plotted and Other Data

Notes:

WR-112 Waveguide Standard Gain Horn Antenna Operating from 7.05 GHz to 10 GHz with a Nominal 15 dBi Gain with CPRG Flange from Fairview Microwave is in-stock and available to ship same-day. All of our RF/microwave products are available off-the-shelf from our ISO 9001:2008 certified facilities in Lewisville, Texas. Fairview Microwave is RF on-demand.

For additional information on this product, please click the following link: [WR-112 Waveguide Standard Gain Horn Antenna Operating from 7.05 GHz to 10 GHz with a Nominal 15 dBi Gain with CPRG Flange FM9858B-15-CPRG](#)

URL:

The information contained in this document is accurate to the best of our knowledge and representative of the part described herein. It may be necessary to make modifications to the part and/or the documentation of the part, in order to implement improvements. Fairview Microwave reserves the right to make such changes as required. Unless otherwise stated, all specifications are nominal. Fairview Microwave does not make any representation or warranty regarding the suitability of the part described herein for any particular purpose, and Fairview Microwave does not assume any liability arising out of the use of any part or documentation.

REVISIONS			
REV.	DESCRIPTION	DATE	APPROVED
A	INITIAL RELEASE	12/02/22	KHIETPAS

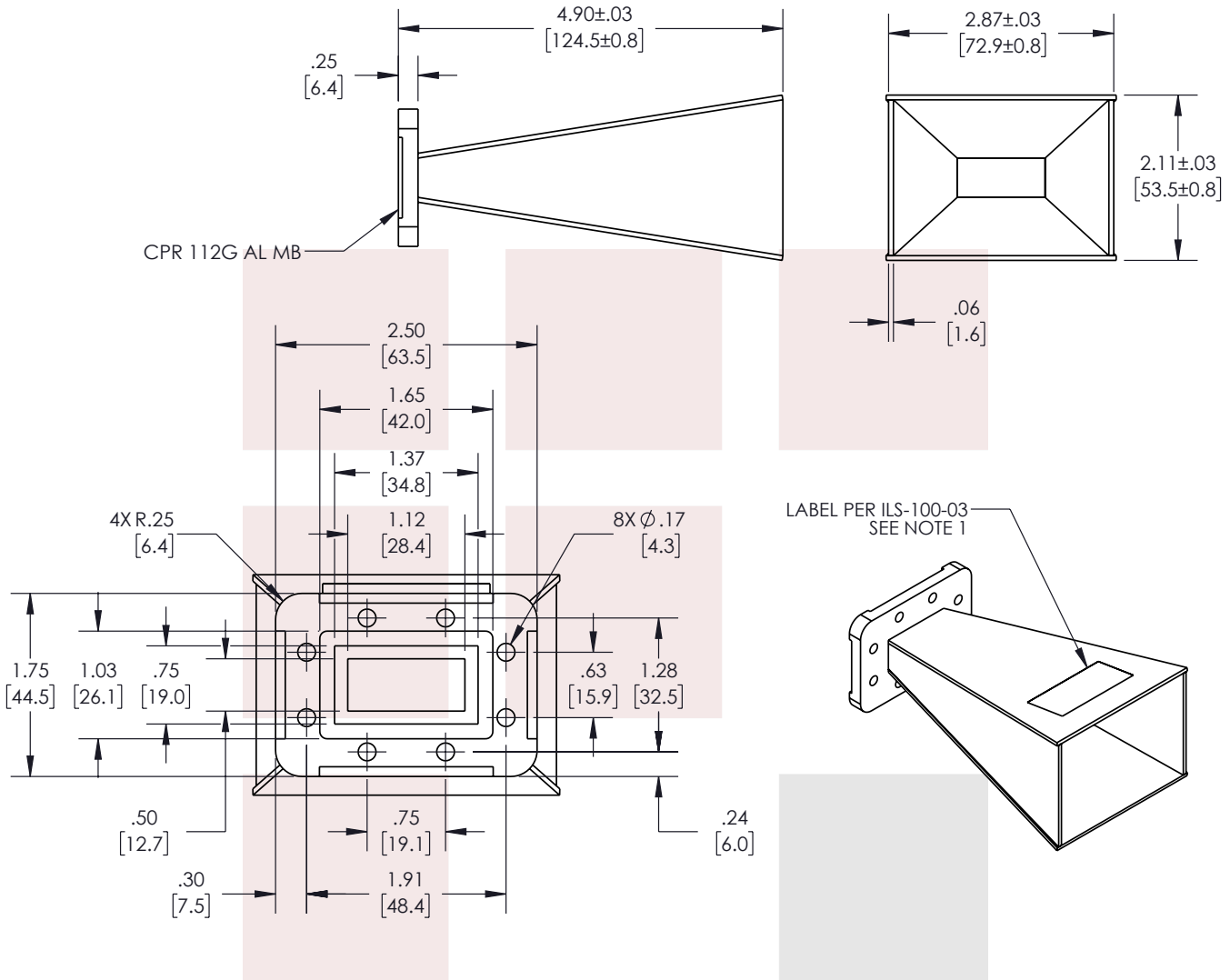

NOTES:

- LABEL PER ILS-100-03 (FOR INTERNAL USE ONLY). LABEL LOCATION SHOWN IS FOR REFERENCE ONLY.

REGULATORY COMPLIANCE:

EU RoHS DIRECTIVE (MOST RECENT RELEASED VERSION)

THESE COMMODITIES, TECHNOLOGY OR SOFTWARE WERE EXPORTED FROM THE UNITED STATES IN ACCORDANCE WITH THE EXPORT ADMINISTRATION REGULATIONS. DIVERSION CONTRARY TO U.S. LAW PROHIBITED.

TITLE

WR-112 Waveguide Standard Gain Horn Antenna
Operating from 7.05 GHz to 10 GHz with a Nominal 15 dBi Gain with CPRG Flange

UNLESS OTHERWISE SPECIFIED LEADING DIMENSIONS ARE INCHES
DIMENSIONS IN [] ARE MILLIMETERS

TOLERANCES:

.X = ±.2 [5.08] FRACTIONS ± 1/32
.XX = ±.02 [.51] ANGLES ± 1°
.XXX = ±.005 [.13]

CABLE LENGTH (L) TOLERANCES:

L ≤ 12 [305] = +1 [25] / -0
12 [305] < L ≤ 60 [1524] = +2 [51] / -0
60 [1524] < L ≤ 120 [3048] = +4 [102] / -0
120 [3048] < L ≤ 300 [7620] = +6 [152] / -0
300 [7620] < L = +5%L / -0

THIRD-ANGLE PROJECTION



THE INFORMATION AND DESIGN IN THIS DOCUMENT IS THE PROPERTY OF FAIRVIEW MICROWAVE CORPORATION. ALL RIGHTS RESERVED.

SHEET 1 OF 1

SCALE N/A

ALL DIMENSIONS SHOWN ARE FOR REFERENCE ONLY.

SIZE A	CAGE CODE 3FKR5	DRAWN BY VTHANGARAJ	ITEM NO. FM9858B-15-CPRG	REV A
-----------	--------------------	------------------------	-----------------------------	----------

T-Rev.D