

Helium Hotspot Antenna Upgrade Kit, 3dBi 800MHz Omni w/ N Male to RP-SMA Plug, 6ft Low Loss 400 Cable

The FMANKIT1024 EU Helium Hotspot Antenna Upgrade Kit from Fairview Microwave was designed with the serious Helium HNT Miner in mind. FMANKIT1024 provides your LongFi radio with the proper components to get the most out of your hotspot with optimized range, increased witnessing and Proof-of-Coverage over OEM components.

The FMANKIT1024 achieves enhanced performance by utilizing Fairview Microwave's 800 MHz high-performance Omni-directional antennas designed for the 800 MHz European ISM band. These LoRa, LoRaWAN antennas feature a rugged 1.3" diameter UV-stable fiberglass radome for durability, aesthetics and long service life. The FMANKIT1024 comes with a 3 dBi Omni Antenna that operates from 824 MHz to 876 MHz frequency range.

Combined with our Low Loss 400 series cable, the 400 cable features equal performance and mechanical characteristics to cables from CommScope®, Times Microwave Systems®, Belden® and Andrew®. This 6 ft Low Loss cable comes terminated with an N Male connector, to the antenna, and an RP-SMA Male connector compatible with the leading Hotspot miners on the market. The FMANKIT1024 from Fairview Microwave brings industry proven components direct to the Helium enthusiast, ship worldwide the same day as with our other available RF parts.

Configuration

Design	Omni
Band Type	Single
Radiation Pattern	Omni Directional
Polarization	Vertical
Cable Type	400 Series
Cable Length	72 in [182.88 cm]
Connector Type	N Female

Electrical Specifications

Description	Min	Typ	Max	Units
Frequency Range	824		876	MHz
Input VSWR		1.5:1		
Impedance		50		Ohms
Gain		3		dBi
Horizontal Beam Width		360		Degrees
Vertical Beam Width		70		Degrees
Input Power			100	Watts

Cable Assembly

Cable Type	400 Series
Impedance	50 Ohms
Connector 1	N Male
Connector 2	SMA Plug Reverse Polarity

Mechanical Specifications

Radome Material	Fiberglass
-----------------	------------

Size

Radome Diameter	1.3 in [33.02 mm]
Overall Length	70 in [177.8 cm]
Width	10 in [254 mm]
Height	4 in [101.6 mm]



Features:

- 824 MHz to 876 MHz
- Increased Proof-of-Coverage
- N-Male to RP-SMA Male Low loss CA-400 series coax cable (LMR-400 equivalent)
- Lightweight fiberglass radome
- Heavy-duty steel mounting bracket
- COAX-SEAL® Hand Moldable Weatherproofing Tape

Applications:

- Helium Network (HNT) Mining
- 800 MHz EU ISM band
- EU868, IN865, RU864
- M2M, LPWAN, LoRA, LoRaWAN, IoT, LongFi
- Industrial & Environmental Monitoring
- Smart Metering Applications
- Inventory Tracking
- Non Line of Sight (NLOS)

Fairview Microwave
301 Leora Ln., Suite 100
Lewisville, TX 75056
Tel: 1-800-715-4396 / (972) 649-6678
Fax: (972) 649-6689
www.fairviewmicrowave.com
sales@fairviewmicrowave.com

Mounting Mast Diameter 1.2 to 2 in [30.48 to 50.80 mm]
Weight 0.4 lbs [181.44 g]

Environmental Specifications

Temperature

Operating Range -40 to +60 deg C
Wind Loading 130 MPH [209.21 KPH]

Compliance Certifications (see [product page](#) for current document)

Plotted and Other Data

Notes:

Helium Hotspot Antenna Upgrade Kit, 3dBi 800MHz Omni w/ N Male to RP-SMA Plug, 6ft Low Loss 400 Cable from Fairview Microwave is in-stock and available to ship same-day. All of our RF/microwave products are available off-the-shelf from our ISO 9001:2008 certified facilities in Lewisville, Texas. Fairview Microwave is RF on-demand.

For additional information on this product, please click the following link: [Helium Hotspot Antenna Upgrade Kit, 3dBi 800MHz Omni w/ N Male to RP-SMA Plug, 6ft Low Loss 400 Cable FMANKIT1024](#)

URL: <https://www.fairviewmicrowave.com/helium-hotspot-antenna-upgrade-kit-6dbi-800mhz-omni-n-male-rp-sma-plug-6ft-low-loss-400-cable-lcankit1024-p.aspx>

The information contained in this document is accurate to the best of our knowledge and representative of the part described herein. It may be necessary to make modifications to the part and/or the documentation of the part, in order to implement improvements. Fairview Microwave reserves the right to make such changes as required. Unless otherwise stated, all specifications are nominal. Fairview Microwave does not make any representation or warranty regarding the suitability of the part described herein for any particular purpose, and Fairview Microwave does not assume any liability arising out of the use of any part or documentation.

REVISIONS			
REV.	DESCRIPTION	DATE	APPROVED
A	INITIAL RELEASE	6/27/2022	K. HIETPAS

N TYPE FEMALE
BULKHEAD CONNECTOR
WITH WASHER AND HEX NUT

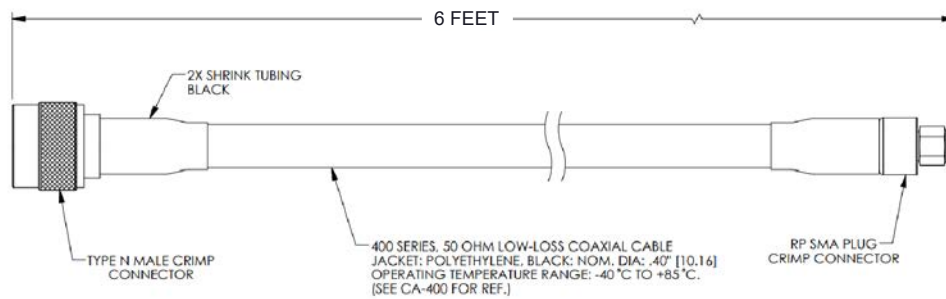
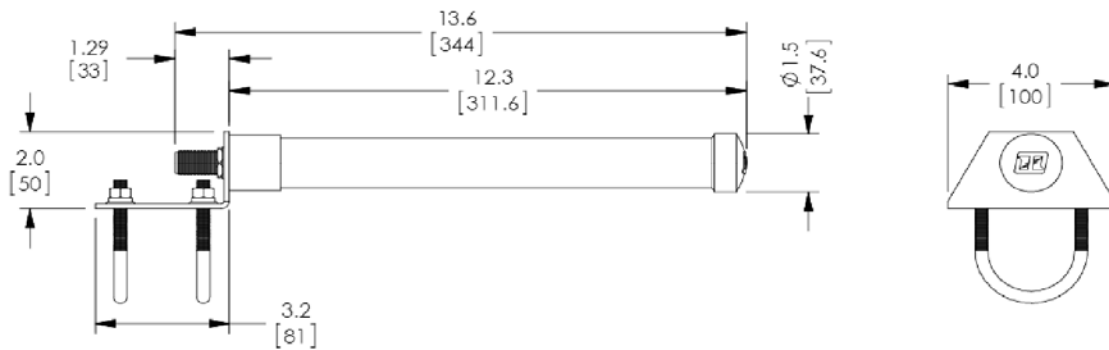
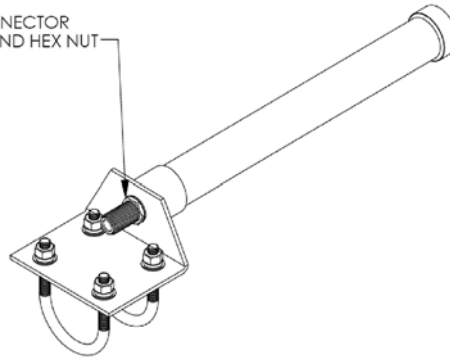

THESE COMMODITIES, TECHNOLOGY OR SOFTWARE WERE EXPORTED FROM THE UNITED STATES IN ACCORDANCE WITH THE EXPORT ADMINISTRATION REGULATIONS. DIVERSION CONTRARY TO U.S. LAW PROHIBITED.

TITLE
Helium Hotspot Antenna Upgrade Kit, 3dBi 800MHz
Omni w/ N Male to RP-SMA Plug, 6ft Low Loss 400
Cable

UNLESS OTHERWISE SPECIFIED LEADING DIMENSIONS ARE INCHES
DIMENSIONS IN [] ARE MILLIMETERS

TOLERANCES: CABLE LENGTH (L) TOLERANCES:

.X = ±.2 [5.08]	FRACTIONS	L ≤ 12 [305] = +1 [25] / -0
.XX = ±.02 [.51]	± 1/32	12 [305] < L ≤ 60 [1524] = +2 [51] / -0
.XXX = ±.005 [.13]	ANGLES ± 1°	60 [1524] < L ≤ 120 [3048] = +4 [102] / -0
		120 [3048] < L ≤ 300 [7620] = +6 [152] / -0
		300 [7620] < L = +5%L / -0

THIRD-ANGLE PROJECTION

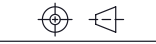

THE INFORMATION AND
DESIGN IN THIS DOCUMENT
IS THE PROPERTY OF
FAIRVIEW MICROWAVE CORPORATION.
ALL RIGHTS RESERVED.

SHEET 1 OF 1

ALL DIMENSIONS SHOWN ARE FOR REFERENCE ONLY.

SCALE N/A

SIZE A	CAGE CODE 3FKR5	DRAWN BY K.DANG	ITEM NO. LCANKIT1024	REV A
-----------	--------------------	--------------------	-------------------------	----------

T-Rev.D