

0 to 20 dB Variable Attenuator SMA Female to SMA Female from 7 GHz to 10 GHz Rated to 5 Watts

FMAT7433-20 from Fairview Microwave is a continuously variable attenuator that has 20 dB of total attenuation with rotary dial design for continuous attenuation level adjustment across a frequency range from 7 to 10GHz. With SMA female connectors, this RF variable attenuator design is tried and true technology that offers exceptional RF performance characteristics that include 0.5 dB maximum insertion loss and a maximum VSWR of 1.5:1. Continuously variable attenuators are part of the comprehensive RF attenuator product offerings from Fairview Microwave which are available in stock and ready for same-day shipment.

Configuration

- Design: Continuously Variable Attenuator
- Body Material and Plating: Aluminum

Electrical Specifications*

Description	Min	Typ	Max	Units
Frequency Range	7		10	GHz
Impedance		50		Ohms
Attenuation Value		0 to 20		dB
Insertion Loss			0.5	dB
Input Power (CW)			5	Watts
Peak Power			3	kWatts
VSWR			1.5:1	

* Values at 25°C, sea level

Mechanical Specifications

Temperature

Operating Range -40 to +85 deg C

Size

Length 3.07 in [77.98 mm]

Width 1.99 in [50.55 mm]

Height 0.5 in [12.7 mm]

Weight 0.19 lbs [86.18 g]

Connectors

Description	Connector 1	Connector 2
Type	SMA Female	SMA Female
Contact Material & Plating	Beryllium Copper, Gold	Beryllium Copper, Gold
Body Material & Plating	Brass, Nickel	Brass, Nickel



Features:

- 20dB Attenuation Level
- Rotary Dial Design for Continuous Adjustment
- Frequency Range from 7GHz to 10GHz
- SMA Female Connectorized Design
- Max VSWR 1.5:1
- Max Power Rating: 5W (CW)

Applications:

- Instrumentation
- Precision Measurements
- Prototyping and Characterization
- Production Systems

Fairview Microwave
301 Leora Ln., Suite 100
Lewisville, TX 75056
Tel: 1-800-715-4396 / (972) 649-6678
Fax: (972) 649-6689
www.fairviewmicrowave.com
sales@fairviewmicrowave.com

Compliance Certifications (see [product page](#) for current document)

Plotted and Other Data

Notes:

- Values at 25 °C, sea level

0 to 20 dB Variable Attenuator SMA Female to SMA Female from 7 GHz to 10 GHz Rated to 5 Watts from Fairview Microwave is in-stock and available to ship same-day. All of our RF/microwave products are available off-the-shelf from our ISO 9001:2008 certified facilities in Lewisville, Texas. Fairview Microwave is RF on-demand.

For additional information on this product, please click the following link: [0 to 20 dB Variable Attenuator SMA Female to SMA Female from 7 GHz to 10 GHz Rated to 5 Watts FMAT7433-20](#)

URL: <https://www.fairviewmicrowave.com/20db-continuously-variable-attenuator-sma-female-sma-female-5-watts-fmat7433-20-p.aspx>

The information contained in this document is accurate to the best of our knowledge and representative of the part described herein. It may be necessary to make modifications to the part and/or the documentation of the part, in order to implement improvements. Fairview Microwave reserves the right to make such changes as required. Unless otherwise stated, all specifications are nominal. Fairview Microwave does not make any representation or warranty regarding the suitability of the part described herein for any particular purpose, and Fairview Microwave does not assume any liability arising out of the use of any part or documentation.

REVISIONS			
REV.	DESCRIPTION	DATE	APPROVED
A	INITIAL RELEASE	02/17/2022	SPONG

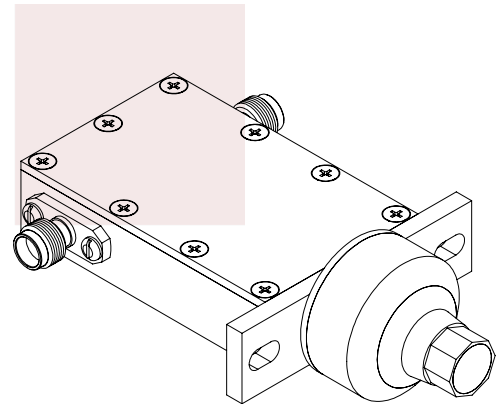
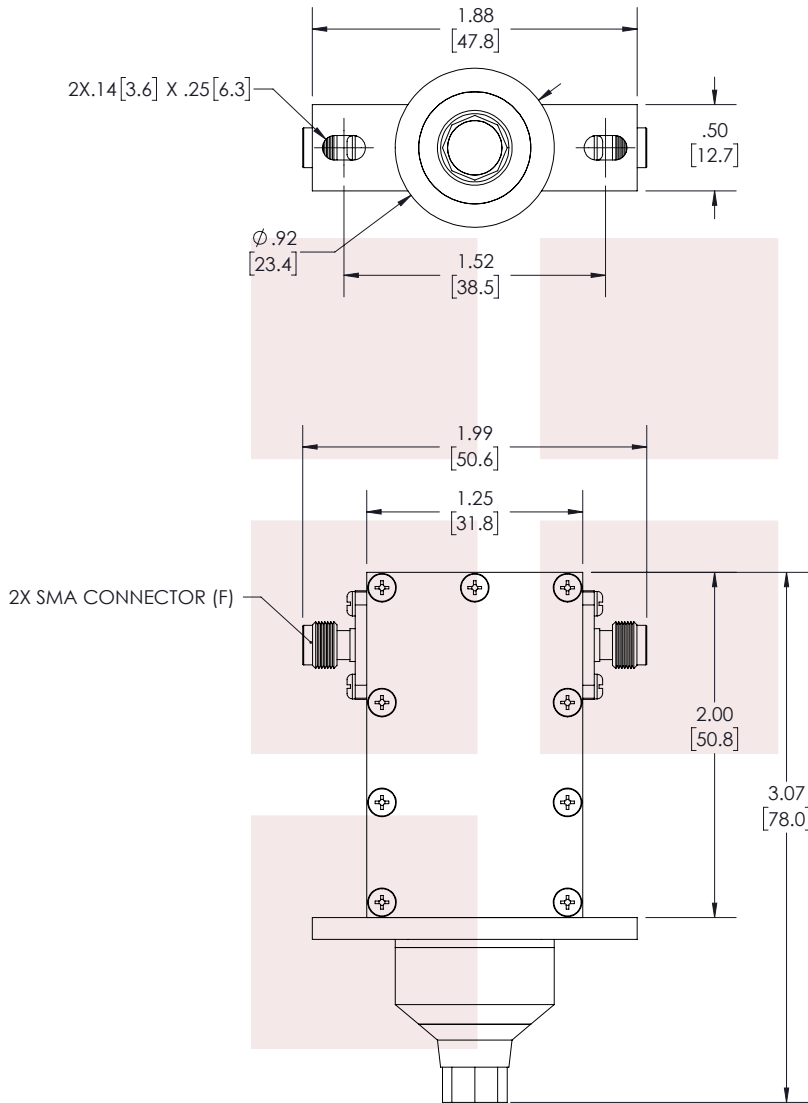

THESE COMMODITIES, TECHNOLOGY OR SOFTWARE WERE EXPORTED FROM THE UNITED STATES IN ACCORDANCE WITH THE EXPORT ADMINISTRATION REGULATIONS. DIVERSION CONTRARY TO U.S. LAW PROHIBITED.

TITLE

0 to 20 dB Variable Attenuator SMA Female to SMA Female from 7 GHz to 10 GHz Rated to 5 Watts

UNLESS OTHERWISE SPECIFIED LEADING DIMENSIONS ARE INCHES
DIMENSIONS IN [] ARE MILLIMETERS

TOLERANCES:

.X = ±.2 [5.08] FRACTIONS ± 1/32
.XX = ±.02 [.51] ANGLES ± 1°
.XXX = ±.005 [.13]

CABLE LENGTH (L) TOLERANCES:

L ≤ 12 [305] = +1 [25] / -0
12 [305] < L ≤ 60 [1524] = +2 [51] / -0
60 [1524] < L ≤ 120 [3048] = +4 [102] / -0
120 [3048] < L ≤ 300 [7620] = +6 [152] / -0
300 [7620] < L = +5%L / -0

THIRD-ANGLE PROJECTION



THE INFORMATION AND DESIGN IN THIS DOCUMENT IS THE PROPERTY OF FAIRVIEW MICROWAVE CORPORATION. ALL RIGHTS RESERVED.

SHEET 1 OF 1

ALL DIMENSIONS SHOWN ARE FOR REFERENCE ONLY.

SCALE

N/A

SIZE A	CAGE CODE 3FKR5	DRAWN BY VTHANGARAJ	ITEM NO. FMAT7433-20	REV A
-----------	--------------------	------------------------	-------------------------	----------

T-Rev.D