

5 dB Fixed Attenuator, 4.3-10 Male (Plug) to 4.3-10 Female (Jack) Up to 6 GHz Rated to 2 Watts, 1.3:1 VSWR



FMAT7451-5

Features

- DC to 6 GHz Frequency Range
- 4.3-10 Connectorized Design
- Attenuation 5 dB \pm 0.5 dB
- Max Power 2 Watts (CW)
- Typical VSWR of 1.3:1

Applications

- Instrumentation
- Precision Measurements
- Prototyping and Characterization
- Production Systems

Description

Fairview Microwave carries a broad selection of fixed attenuators with a wide range of attenuation levels, frequency ranges, and power dissipation ranges. Also known as RF pads, RF microwave attenuators lower the amplitude of a signal (or attenuate) a known amount. These attenuator pads can be used in a wide variety of applications including reducing a signal level to protect measurement equipment or other circuitry, extending the range of power meters and amplifiers, and impedance matching circuits by reducing the VSWR seen by adjacent components. RF attenuators can prevent signal overload in amplifiers, receivers and detectors, adjusting the signal level to a range that is optimal.

Few RF components are as commonly used as fixed coaxial attenuators, and Fairview Microwave carries one of the largest in-stock varieties and ships them same day. The FMAT7451-5 is a 5 dB Fixed Attenuator that operates from DC to 6 GHz and is rated to 2 Watts. The versatile coaxial package uses 4.3-10 male to 4.3-10 female connectors.

Electrical Specifications

Description	Minimum	Typical	Maximum	Units
Frequency Range	DC		6	GHz
Impedance		50		Ohms
Nominal Attenuation		5		dB
Attenuation Accuracy			\pm 0.5	dB
VSWR			1.3:1	
Input Power, CW			2	Watts
Input Power, Peak			500	Watts
5 μ s PW, 0.4% duty cycle				

Mechanical Specifications

Size

Length	2.874 in [73 mm]
Width/Diameter	0.709 in [18.01 mm]
Height	0.709 in [18.01 mm]
Weight	0.5 lbs [226.8 g]
Body Material and Plating	Brass, Nickel

Configuration

Design	Fixed
Package Style	Connectorized

5 dB Fixed Attenuator, 4.3-10 Male (Plug) to 4.3-10 Female (Jack) Up to 6 GHz Rated to 2 Watts, 1.3:1 VSWR



FMAT7451-5

Connectors

Description	Connector 1	Connector 2
Type	4.3-10 Male	4.3-10 Female
Contact Material and Plating	Brass, Gold	Beryllium Copper, Gold
Body Material and Plating	Brass, Nickel	Brass, Nickel

Environmental Specifications

Temperature

Operating Range	-55 to +125 deg C
Storage Range	-55 to +125 deg C

Compliance Certifications (see [product page](#) for current document)

Plotted and Other Data

Notes:

Typical Performance Data

5 dB Fixed Attenuator, 4.3-10 Male (Plug) to 4.3-10 Female (Jack) Up to 6 GHz Rated to 2 Watts, 1.3:1 VSWR from Fairview Microwave is in-stock and available to ship same-day. All of our RF/microwave products are available off-the-shelf from our ISO 9001:2008 certified facilities in Lewisville, Texas. Fairview Microwave is RF on-demand.

For additional information on this product, please click the following link: [5 dB Fixed Attenuator, 4.3-10 Male \(Plug\) to 4.3-10 Female \(Jack\) Up to 6 GHz Rated to 2 Watts, 1.3:1 VSWR FMAT7451-5](#)

URL: <https://www.fairviewmicrowave.com/5db-fixed-attenuator-4.3-10-male-4.3-10-female-2-watts-fmat7451-5-p.aspx>

The information contained within this document is accurate to the best of our knowledge and representative of the part described herein. It may be necessary to make modifications to the part and/or the documentation of the part in order to implement improvements. Fairview Microwave reserves the right to make such changes as required. Unless otherwise stated, all specifications are nominal. Fairview Microwave does not make any representation or warranty regarding the suitability of the part described herein for any particular purpose, and Fairview Microwave does not assume liability arising out of the use of any part or document.

FMAT7451-5 CAD Drawing

5 dB Fixed Attenuator, 4.3-10 Male (Plug) to 4.3-10 Female (Jack) Up to 6 GHz Rated to 2 Watts, 1.3:1 VSWR

REVISIONS			
REV.	DESCRIPTION	DATE	APPROVED
A	INITIAL RELEASE	12/28/2022	SPONG

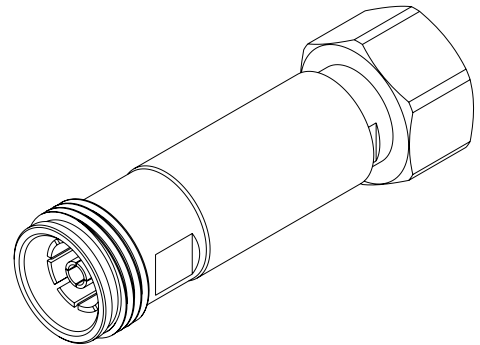
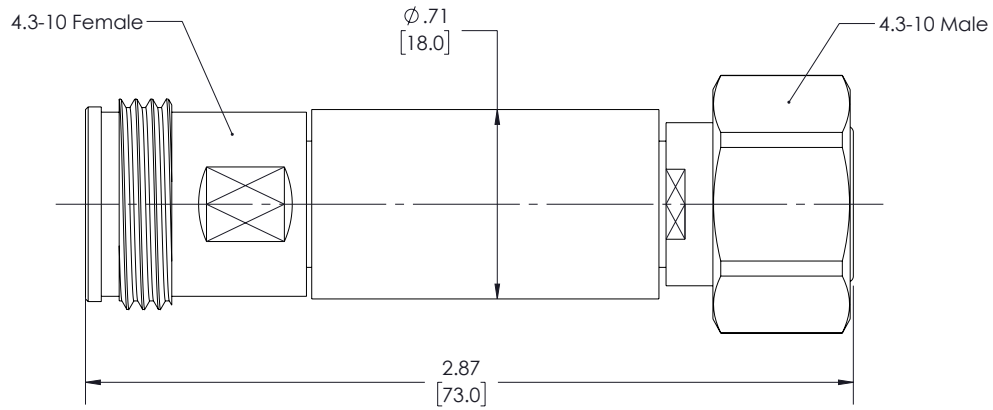

THESE COMMODITIES, TECHNOLOGY OR SOFTWARE WERE EXPORTED FROM THE UNITED STATES IN ACCORDANCE WITH THE EXPORT ADMINISTRATION REGULATIONS. DIVERSION CONTRARY TO U.S. LAW PROHIBITED.



TITLE

UNLESS OTHERWISE SPECIFIED LEADING DIMENSIONS ARE INCHES
DIMENSIONS IN [] ARE MILLIMETERS

TOLERANCES:

.X = ±.2 [5.08] FRACTIONS ± 1/32
.XX = ±.02 [.51] ANGLES ± 1°
.XXX = ±.005 [.13]

CABLE LENGTH (L) TOLERANCES:

L ≤ 12 [305] = +1 [25] / -0
12 [305] < L ≤ 60 [1524] = +2 [51] / -0
60 [1524] < L ≤ 120 [3048] = +4 [102] / -0
120 [3048] < L ≤ 300 [7620] = +6 [152] / -0
300 [7620] < L = +5%L / -0

THIRD-ANGLE PROJECTION

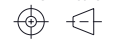

THE INFORMATION AND DESIGN IN THIS DOCUMENT IS THE PROPERTY OF FAIRVIEW MICROWAVE CORPORATION. ALL RIGHTS RESERVED.

SHEET 1 OF 1

SCALE

N/A

ALL DIMENSIONS SHOWN ARE FOR REFERENCE ONLY.

SIZE	CAGE CODE	DRAWN BY	ITEM NO.	REV
A	3FKR5	PSRINIVAS	FMAT7451-5	A

T-Rev.D