

**SP6T Latching DC to 26.5 GHz Terminated Electro-Mechanical Relay Switch, up to 90W, 12V, SMA**

The FMSW6378 is a Single Pole Six Throw (SP6T) electromechanical relay switch that operates across a wide frequency range of DC to 26.5 GHz and can handle up to 90 Watts of CW input power in a break before make condition. The design features a Latching actuator and is rated for 5M life cycles for high reliability operation. Impressive performance includes insertion loss less than 0.15 dB typical and isolation greater than 80 dB typical. The Latching actuator has 50 Ohm Terminations and a +12 Vdc bias voltage, and operates over a temperature range of -25°C to +70°C. The rugged and compact package assembly supports SMA Female connectors and a 15 Pin D-Sub Connector for DC Control. And for highly reliable operation, the model is guaranteed to meet MIL-STD-202 environmental test conditions for shock and random vibration.

**Electrical Specifications**

Switch Type	SP6T, Terminated
Actuator Type	Latching
Switching Sequence	Break before Make

Description	Min	Typ	Max	Units
Frequency Range	DC		26.5	GHz
Impedance		50		Ohms
Termination Impedance		50		Ohms
Operating Voltage	11	12	13	Volts
Actuating Current @ 12 Volts		200		mA
VSWR		1.2:1	1.7:1	
Insertion Loss		0.15	0.7	dB
Insertion Loss Repeatability				
Isolation	70	80		dB
Input Power (CW)			50	Watts
Termination Input Power (CW)			5	Watts
Switching Time			20	ms

**Performance by Frequency**

Description	F1	F2	F3	F4	F5	Units
Frequency Range	DC - 6	6 - 12	12 - 18	18 - 26.5		GHz
VSWR, Max	1.2:1	1.3:1	1.4:1	1.7:1		
Insertion Loss, Max	0.15	0.25	0.4	0.7		dB
Isolation, Min	80	80	80	70		dB
Power In, Typ (CW)	90	75	60	50		Watts

**Mechanical Specifications**

<b>Size</b>	
Weight	0.41 lbs [185.97 g]
Package Type	Connectorized
Operating Life	5,000,000 Cycles



**Features:**

- Single Pole Six Throw
- DC to 26.5 GHz Frequency Range
- Isolation greater than 80 dB typical
- 5M Cycle Min Operating Life
- +12 Volt DC
- 90 Watt average Power
- Latching Actuator
- Internally Terminated
- -25 to +70°C Operating Temperature
- Insertion Loss as low as 0.2 dB Max
- VSWR as low as 1.2:1 max
- SMA Female RF connectors
- 15 Pin D-Sub Connector for DC Control
- Hot Switching Capability - Consult Factory
- S-Parameter Data available upon request

**Applications:**

- High Performance Relay Switch
- Military Communications
- Communications Systems
- Test & Measurement

Fairview Microwave  
1130 Junction Dr. #100  
Allen, TX 75013  
Tel: 1-800-715-4396 / (972) 649-6678  
Fax: (972) 649-6689  
[www.fairviewmicrowave.com](http://www.fairviewmicrowave.com)  
[sales@fairviewmicrowave.com](mailto:sales@fairviewmicrowave.com)

**Connectors**

RF Connector Type SMA Female  
 Control Connector 15 Pin D-Sub

**Environmental Specifications**

**Temperature**

Operating Range -25 to +70 deg C  
 Storage Range -55 to +100 deg C

Shock MIL-STD-202 Method 213, Cond. D 500G Non Operating  
 Vibration MIL-STD-202 Method 214, Cond. D 10G RMS Non Operating

**Compliance Certifications** (see [product page](#) for current document)

**Plotted and Other Data**

Notes:

**Typical Performance Data**

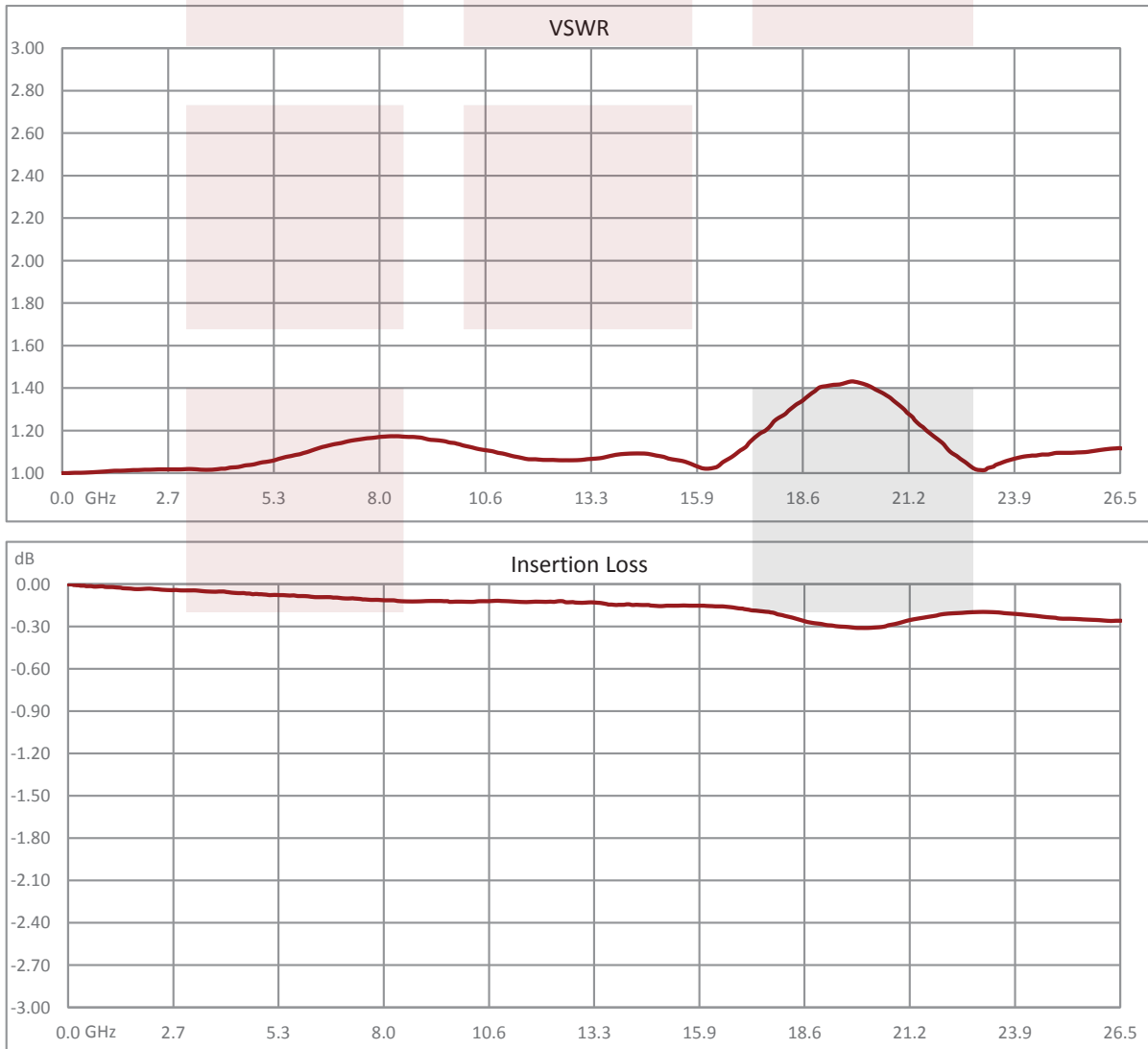

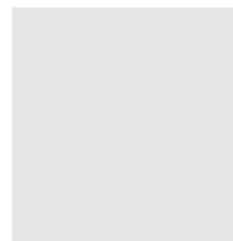
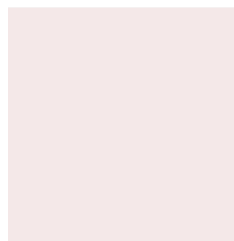
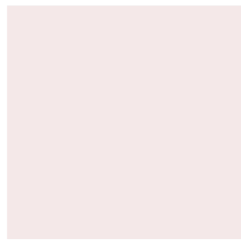
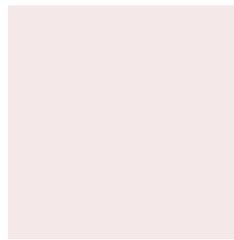
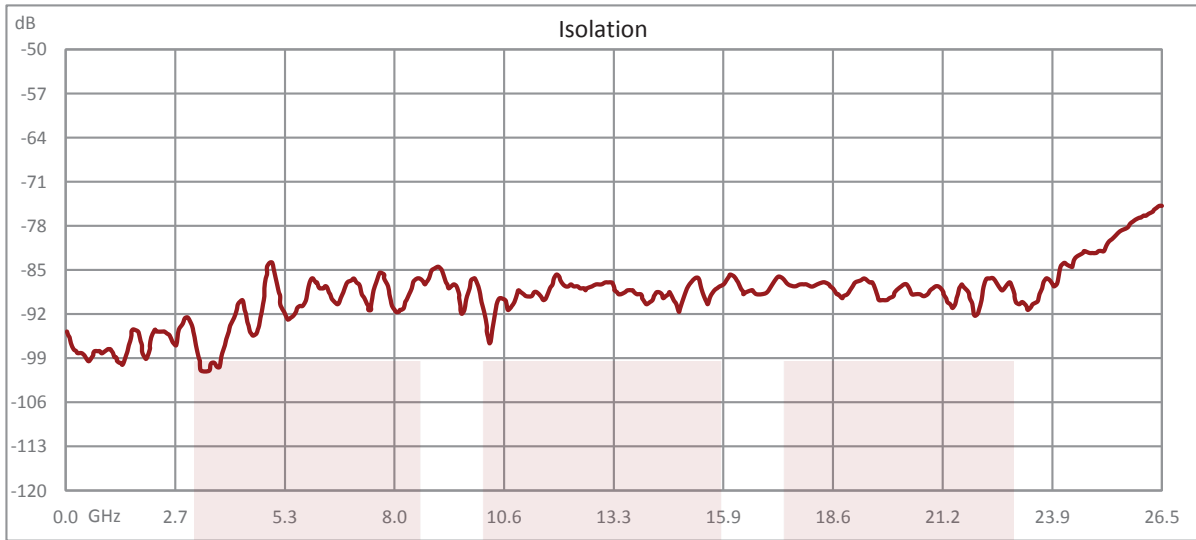

**Power Handling vs. Frequency & Connector Type**

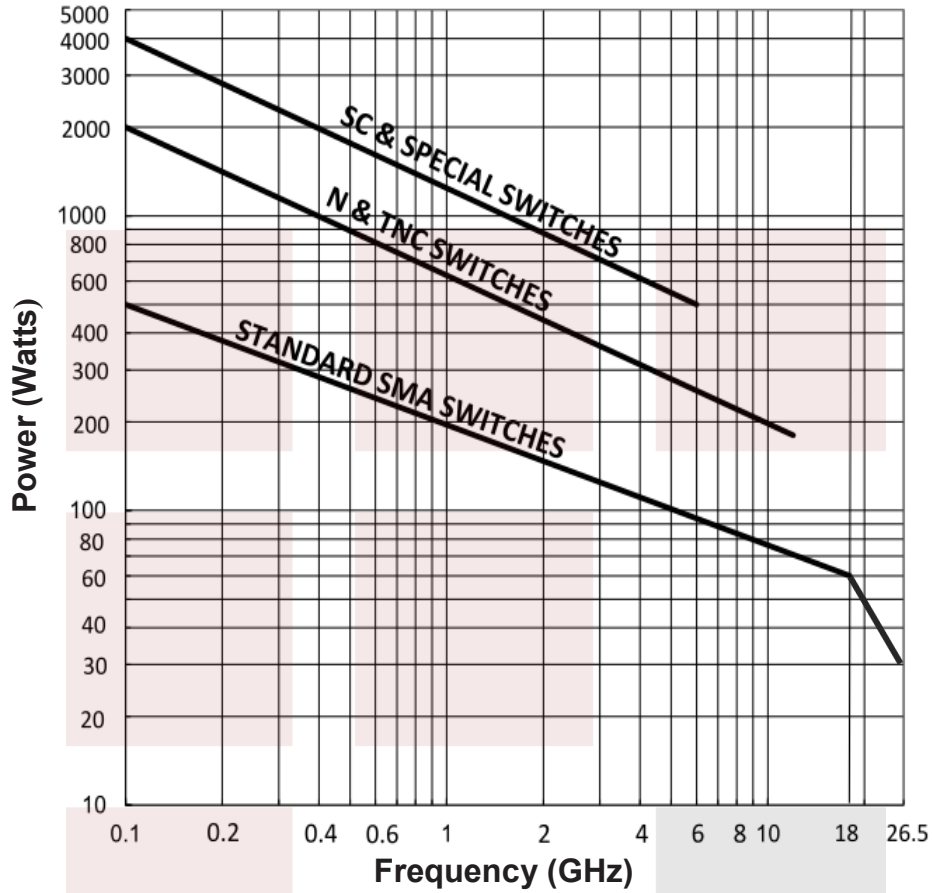

**Environmental and Test Conditions:**

- Ambient temperature of 25°C or less
- Altitude: Sea Level
- Load VSWR: 1.20:1 max.
- Cold Switching

SP6T Latching DC to 26.5 GHz Terminated Electro-Mechanical Relay Switch, up to 90W, 12V, SMA from Fairview Microwave is in-stock and available to ship same-day. All of our RF/microwave products are available off-the-shelf from our ISO 9001:2008 certified facilities in Allen, Texas. Fairview Microwave is RF on-demand.

For additional information on this product, please click the following link: [SP6T Latching DC to 26.5 GHz Terminated Electro-Mechanical Relay Switch, up to 90W, 12V, SMA FMSW6378](#)

URL: <https://www.fairviewmicrowave.com/sp6t-latching-26.5-ghz-terminated-electro-mechanical-relay-switch-50w-12v-sma-fmsw6378-p.aspx>

The information contained in this document is accurate to the best of our knowledge and representative of the part described herein. It may be necessary to make modifications to the part and/or the documentation of the part, in order to implement improvements. Fairview Microwave reserves the right to make such changes as required. Unless otherwise stated, all specifications are nominal. Fairview Microwave does not make any representation or warranty regarding the suitability of the part described herein for any particular purpose, and Fairview Microwave does not assume any liability arising out of the use of any part or documentation.



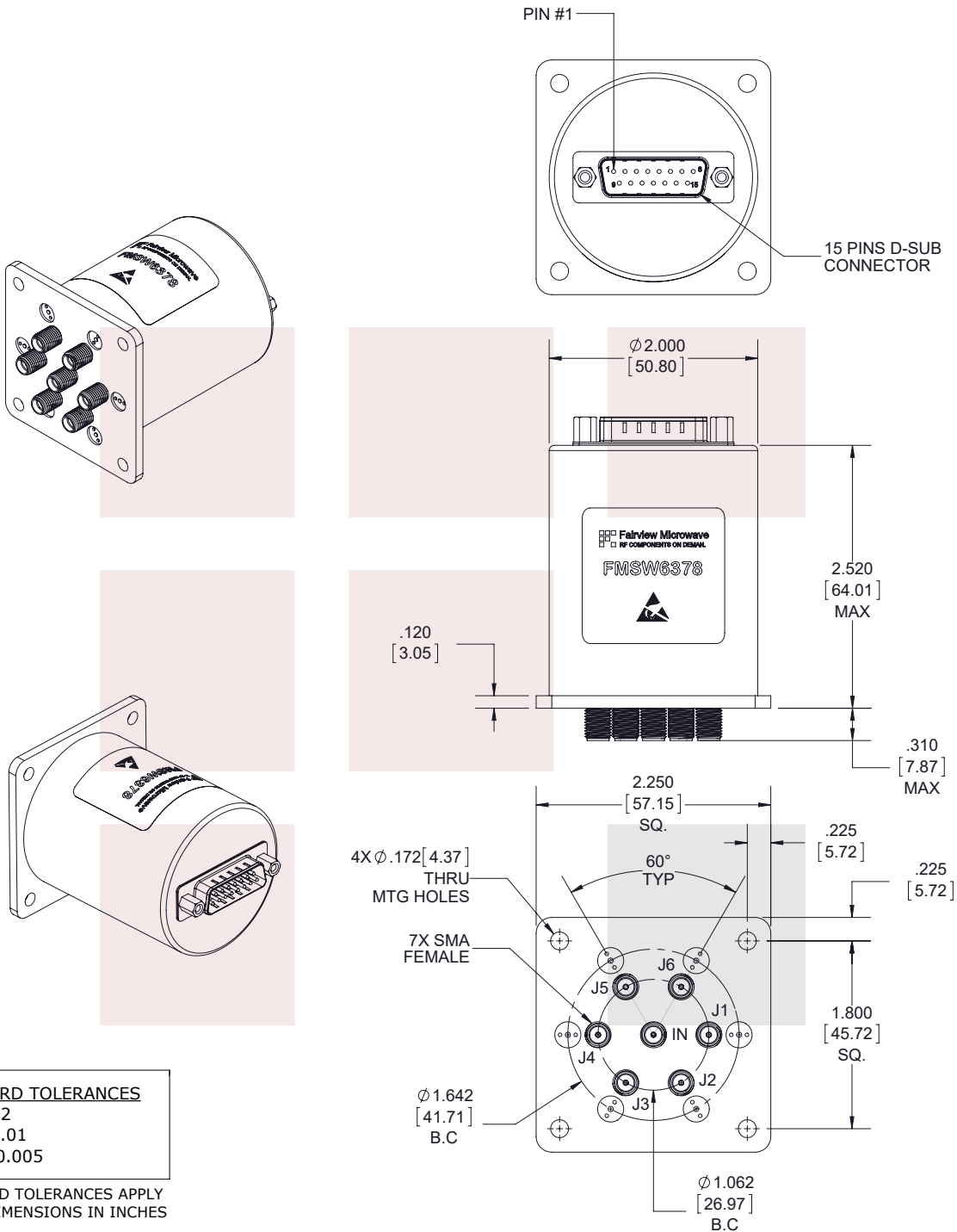

<b>FAIRVIEW MICROWAVE INC.</b> ALLEN, TX 75013 WWW.FAIRVIEWMICROWAVE.COM		NOTES: 1. UNLESS OTHERWISE SPECIFIED ALL DIMENSIONS ARE NOMINAL. 2. ALL SPECIFICATIONS ARE SUBJECT TO CHANGE WITHOUT NOTICE AT ANY TIME. 3. DIMENSIONS ARE IN INCHES [mm].						
TITLE SP6T Latching DC to 26.5 GHz Terminated Electro-Mechanical Relay Switch, up to 90W, 12V, SMA		DWG NO <b>FMSW6378</b>		CAGE CODE <b>3FKR5</b>				
CAD FILE	091117	SHEET	1 OF 2	SCALE	N/A	SIZE	A	7361

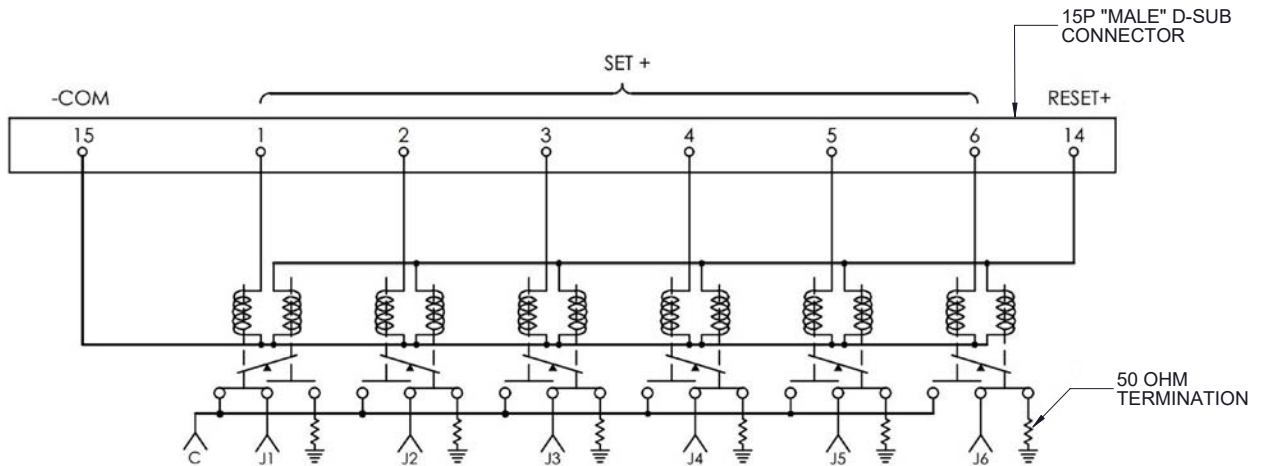

**SCHEMATIC SHOWN IN LATCHING POSITION**

*(COIL 1 SHOWN LAST ENERGIZED)*

TERMINALS D-SUB PIN ASSIGNMENT	RF PATH					
	J1	J2	J3	J4	J5	J6
1 (SET+)	ON	OFF	OFF	OFF	OFF	OFF
2 (SET+)	OFF	ON	OFF	OFF	OFF	OFF
3 (SET+)	OFF	OFF	ON	OFF	OFF	OFF
4 (SET+)	OFF	OFF	OFF	ON	OFF	OFF
5 (SET+)	OFF	OFF	OFF	OFF	ON	OFF
6 (SET+)	OFF	OFF	OFF	OFF	OFF	ON
14 (RESET+)	ALL OFF					

PIN 15. -COM

<b>FAIRVIEW MICROWAVE INC.</b> ALLEN, TX 75013 WWW.FAIRVIEWMICROWAVE.COM	NOTES: 1. UNLESS OTHERWISE SPECIFIED ALL DIMENSIONS ARE NOMINAL. 2. ALL SPECIFICATIONS ARE SUBJECT TO CHANGE WITHOUT NOTICE AT ANY TIME. 3. DIMENSIONS ARE IN INCHES [mm].					
	TITLE SP6T Latching DC to 26.5 GHz Terminated Electro-Mechanical Relay Switch, up to 90W, 12V, SMA	DWG NO <b>FMSW6378</b>	CAGE CODE <b>3FKR5</b>			
	CAD FILE 091117	SHEET 2 OF 2	SCALE N/A	SIZE A	7361	