

Transfer Electromechanical Relay Failsafe Switch, DC to 40 GHz, up to 10W, 2M Lifecycles, 28V, 2.92mm

The FMSW6450 is a Transfer electromechanical relay switch that operates across a wide frequency range of DC to 40 GHz and can handle up to 10 Watts of Average power in a break before make condition. The 50 Ohm design features a Failsafe Actuator and is rated for 2 million lifecycles. Impressive typical performance includes 0.4 dB insertion loss and isolation greater than 80 dB. This switch requires +28Vdc bias voltage and operates over a temperature range of -25°C to +65°C. The rugged and compact package assembly supports 2.92mm female connectors and solder terminal pins for DC control. And for highly reliable operation, the model is guaranteed to meet MIL-STD-202 environmental test conditions for shock and random vibration.

Electrical Specifications

Switch Type	DPDT
Actuator Type	Failsafe
Switching Sequence	Break Before Make

Description	Min	Typ	Max	Units
Frequency Range	DC		40	GHz
Impedance		50		Ohms
Operating Voltage	24	28	30	Volts
Actuating Current @ 28 Volts			400	mA
VSWR		1.4:1	1.8:1	
Insertion Loss		0.4	1	dB
Isolation	50	80		dB
Switching Time			20	ms

Performance by Frequency

Description	F1	F2	F3	F4	F5	Units
Frequency Range	DC - 6	6 - 12.4	12.4 - 26.5	26.5 - 40		GHz
VSWR, Max	1.2:1	1.3:1	1.4:1	1.8:1		
Insertion Loss, Max	0.2	0.4	0.7	1		dB
Isolation, Min	85	80	65	50		dB

Mechanical Specifications

Size	
Length	1.75 in [44.45 mm]
Width/Diameter	1.26 in [32 mm]
Height	1.26 in [32 mm]
Finish	NICKEL
Package Type	Connectorized
Operating Life	2,000,000 Cycles

Connectors

RF Connector Type	2.92mm Female
-------------------	---------------



Features:

- Transfer Electromechanical Relay Switch
- DC to 40 GHz Frequency Range
- Failsafe Actuator
- 2M Lifecycle Rating
- Insertion Loss 0.4 dB typ
- Isolation > 80 dB typ
- VSWR as low as 1.2:1 max
- +28 Volt DC Bias
- Solder Terminal Pins for DC Control
- 2.92mm Female Connectors
- -25°C to +65°C Operating Temperature
- Up to 10 Watt Average Power Handling
- 50 Ohm Design
- Hot Switching Capability - Consult Factory
- S-Parameter Data available upon request
- Rugged Design meets Mil-STD-202 Test Conditions

Applications:

- Aerospace & Defense
- Test & Measurement
- Microwave Radio Systems
- Military & Commercial Communication Systems
- Research & Development
- SATCOM
- Wireless Communications
- Enterprise
- IoT

Fairview Microwave
 301 Leora Ln., Suite 100
 Lewisville, TX 75056
 Tel: 1-800-715-4396 / (972) 649-6678
 Fax: (972) 649-6689
www.fairviewmicrowave.com
sales@fairviewmicrowave.com

Environmental Specifications

Temperature

Operating Range -25 to +65 deg C
Storage Range -55 to +100 deg C

Humidity Moisture resistant or immersion sealing available
Shock MIL-STD-202 Method 213, Condition D, 500G (non oper)
Vibration MIL-STD-202 Method 214, Condition D, 10G RMS (non oper)

Compliance Certifications (see [product page](#) for current document)

Plotted and Other Data

Notes:

Typical Performance Data

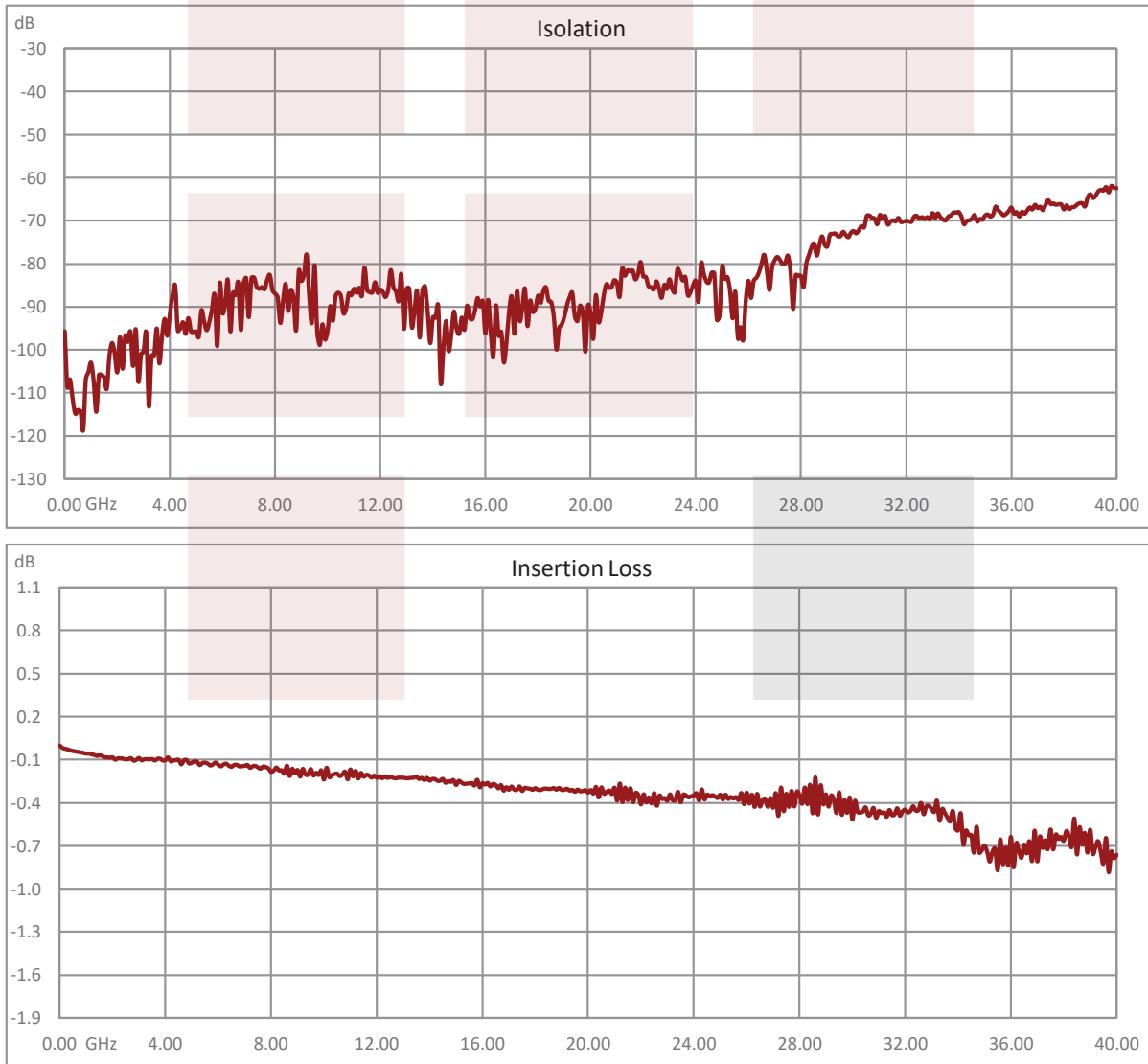

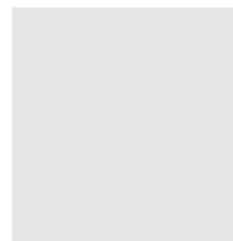
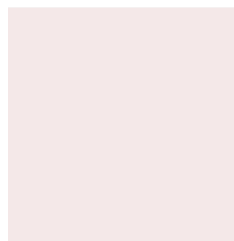
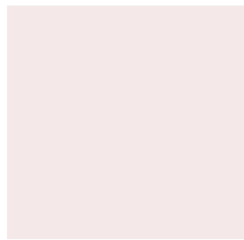
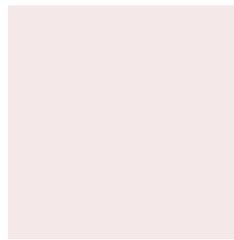
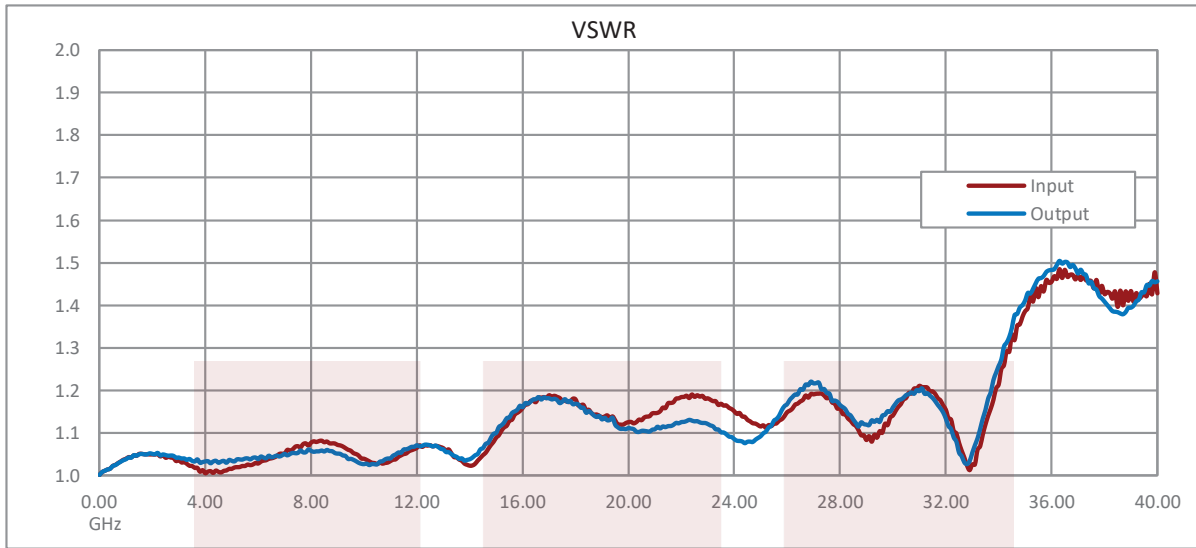

Power Handling vs. Frequency

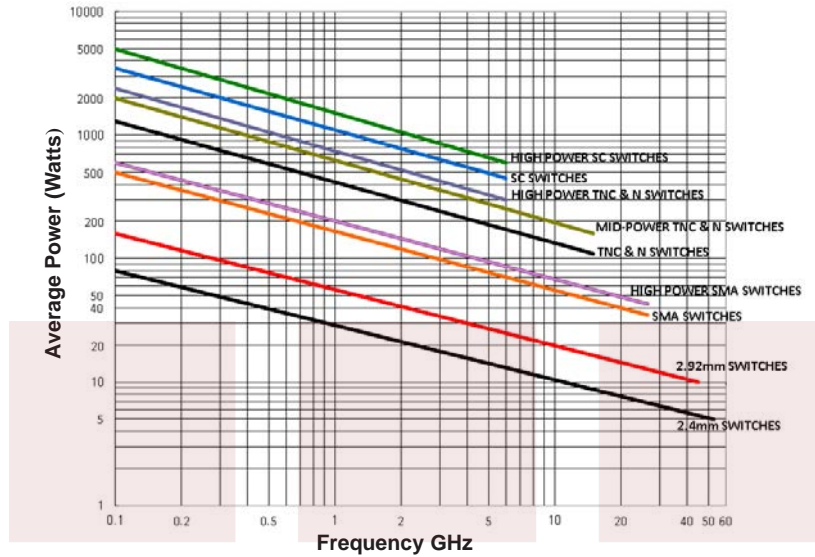

Power Handling De-rating vs. Load VSWR

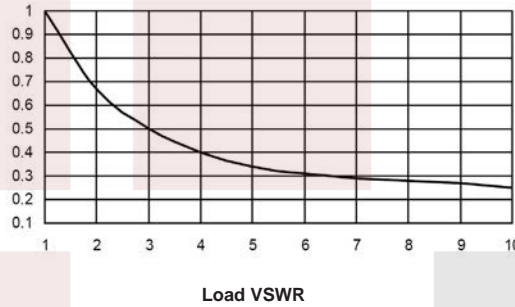

Power Handling Chart and Derating Curves based on the following Test and Environmental Conditions:
 Ambient temperature: 20 - 25°C
 Altitude: Sea Level to 1,000 feet
 Relative Humidity: 50 - 55%
 Load VSWR: ≤ 1.20:1
 Operation: Cold Switching

Transfer Electromechanical Relay Failsafe Switch, DC to 40 GHz, up to 10W, 2M Lifecycles, 28V, 2.92mm from Fairview Microwave is in-stock and available to ship same-day. All of our RF/microwave products are available off-the-shelf from our ISO 9001:2008 certified facilities in Lewisville, Texas. Fairview Microwave is RF on-demand.

For additional information on this product, please click the following link: [Transfer Electromechanical Relay Failsafe Switch, DC to 40 GHz, up to 10W, 2M Lifecycles, 28V, 2.92mm FMSW6450](#)

URL: <https://www.fairviewmicrowave.com/dpdt-failsafe-40-ghz-electro-mechanical-relay-switch-28v-2.92mm-fm-sw6450-p.aspx>

The information contained in this document is accurate to the best of our knowledge and representative of the part described herein. It may be necessary to make modifications to the part and/or the documentation of the part, in order to implement improvements. Fairview Microwave reserves the right to make such changes as required. Unless otherwise stated, all specifications are nominal. Fairview Microwave does not make any representation or warranty regarding the suitability of the part described herein for any particular purpose, and Fairview Microwave does not assume any liability arising out of the use of any part or documentation.



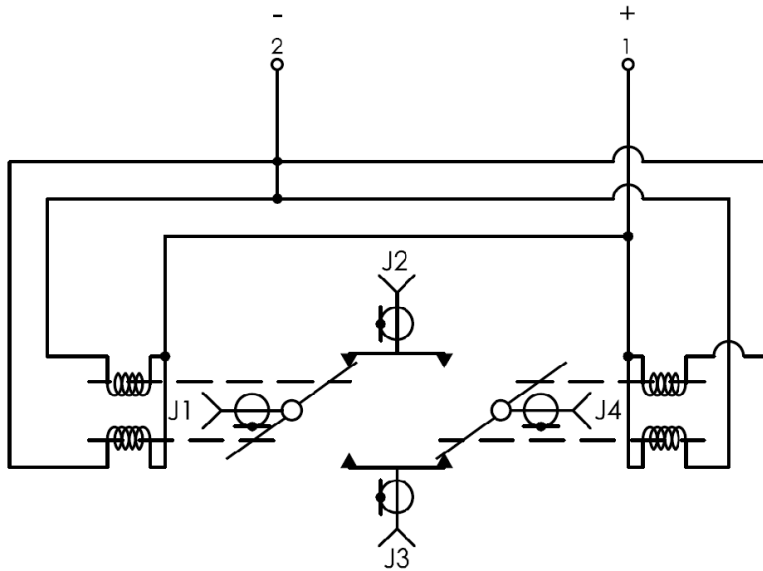

VOLTAGE	RF PATH
DE-ENERGIZED	J1-J2, J3-J4
ENERGIZED	J1-J3, J2-J4

SCHEMATIC

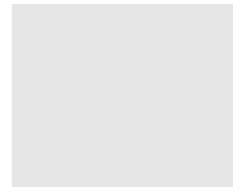
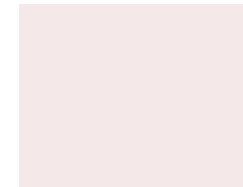

THESE COMMODITIES, TECHNOLOGY OR SOFTWARE WERE EXPORTED FROM THE UNITED STATES IN ACCORDANCE WITH THE EXPORT ADMINISTRATION REGULATIONS. DIVERSION CONTRARY TO U.S. LAW PROHIBITED.

TITLE
Transfer Electromechanical Relay Failsafe Switch, DC to 40 GHz, up to 10W, 2M Lifecycles, 28V, 2.92mm

UNLESS OTHERWISE SPECIFIED LEADING DIMENSIONS ARE INCHES
DIMENSIONS IN [] ARE MILLIMETERS

TOLERANCES: CABLE LENGTH (L) TOLERANCES:

.X = ±.2 [5.08]	FRACTIONS	L ≤ 12 [305] = +1 [25] / -0
.XX = ±.02 [.51]	± 1/32	12 [305] < L ≤ 60 [1524] = +2 [51] / -0
.XXX = ±.005 [.13]	ANGLES ± 1°	60 [1524] < L ≤ 120 [3048] = +4 [102] / -0
		120 [3048] < L ≤ 300 [7620] = +6 [152] / -0
		300 [7620] < L = +5%L / -0

THIRD-ANGLE PROJECTION



THE INFORMATION AND DESIGN IN THIS DOCUMENT IS THE PROPERTY OF FAIRVIEW MICROWAVE CORPORATION. ALL RIGHTS RESERVED.

SHEET 2 OF 2

ALL DIMENSIONS SHOWN ARE FOR REFERENCE ONLY.

SCALE N/A

SIZE A	CAGE CODE 3FKR5	DRAWN BY K.DANG	ITEM NO. FMSW6450	REV A
-----------	--------------------	--------------------	----------------------	----------

T-Rev.D