

## SP4T E-M Relay Latching Switch, Self Cut-Off, Terminated, DC to 26.5 GHz, 90W, 5M Lifecycles, 28V, Indicators, TTL, Suppression Diodes, SMA

The FMSW6474 is a Single Pole Four Throw electromechanical relay switch that operates across a wide frequency range of DC to 26.5 GHz and can handle up to 90 Watts of Average power in a break before make condition. The design is rated for 5 million lifecycles and features a Latching Self Cut-Off Actuator that magnetically latches in place after the control voltage is removed. For power sensitive applications, this is the best actuator option. The output ports are terminated in 50 ohms when switched in the isolation (off) state. Additional features include TTL control logic, suppression diodes which limit voltage spikes or reverse current, and indicators. Impressive typical performance includes 0.3 dB insertion loss and isolation greater than 85 dB. This switch requires +28Vdc bias voltage and operates over a temperature range of -25°C to +65°C. The rugged and compact package assembly supports SMA female connectors and solder terminal pins for DC command control functions. And for highly reliable operation, the model is guaranteed to meet MIL-STD-202 environmental test conditions for shock and random vibration.

### Electrical Specifications

Switch Type	SP4T, Terminated
Actuator Type	Latching
Switching Sequence	Break Before Make
Actuator Options	Self Cut Off, Indicators, TTL Logic, Solder Pins
TTL Control	on: 2.4 to 5 Volts off: 0 to 0.8 Volts

Description	Min	Typ	Max	Units
Frequency Range	DC		26.5	GHz
Impedance		50		Ohms
Operating Voltage	26	28	30	Volts
Actuating Current @ 28 Volts @ 28V AND 20°C			110	mA
Actuating Reset Current			440	mA
VSWR		1.3:1	1.7:1	
Insertion Loss		0.3	0.7	dB
Isolation	70	85		dB
Switching Time			20	ms

### Performance by Frequency

Description	F1	F2	F3	F4	F5	Units
Frequency Range	DC - 6	6 - 12	12 - 18	18 - 26.5		GHz
VSWR, Max	1.2:1	1.3:1	1.4:1	1.7:1		
Insertion Loss, Max	0.15	0.25	0.4	0.7		dB
Isolation, Min	80	80	80	70		dB



### Features:

- Single Pole Four Throw Electromechanical Relay Switch
- DC to 26.5 GHz Frequency Range
- Latching Actuator with Self Cut-Off
- TTL Logic Control
- Suppression Diodes
- Indicators
- 5M Lifecycle Rating
- Insertion Loss 0.3 dB typ
- Isolation > 85 dB typ
- Internally Terminated
- VSWR as low as 1.2:1 max
- +28 Volt DC Bias
- Solder Terminal Pins for DC Command Control
- SMA Female Connectors
- -25°C to +65°C Operating Temperature
- Up to 90 Watt Average Power Handling
- 50 Ohm Design
- Hot Switching Capability - Consult Factory
- S-Parameter Data available upon request
- Rugged Design meets MIL-STD-202 Test Conditions

### Applications:

- Aerospace & Defense
- Test & Measurement
- Microwave Radio Systems
- Military & Commercial Communication Systems
- Research & Development
- SATCOM
- Wireless Communications
- Enterprise

Fairview Microwave  
 301 Leora Ln., Suite 100  
 Lewisville, TX 75056  
 Tel: 1-800-715-4396 / (972) 649-6678  
 Fax: (972) 649-6689  
[www.fairviewmicrowave.com](http://www.fairviewmicrowave.com)  
[sales@fairviewmicrowave.com](mailto:sales@fairviewmicrowave.com)

**Mechanical Specifications**

**Size**

Length 2.52 in [64.01 mm]  
Width/Diameter 2.25 in [57.15 mm]  
Height 2.25 in [57.15 mm]

Finish NICKEL  
Package Type Connectorized

Operating Life 5,000,000 Cycles

**Connectors**

RF Connector Type SMA Female

**Environmental Specifications**

**Temperature**

Operating Range -25 to +65 deg C  
Storage Range -55 to +100 deg C

Humidity Moisture resistant or immersion sealing available  
Shock MIL-STD-202 Method 213, Condition D, 500G (non oper)  
Vibration MIL-STD-202 Method 214, Condition D, 10G RMS (non oper)

**Compliance Certifications** (see [product page](#) for current document)

**Plotted and Other Data**

Notes:

**Typical Performance Data**

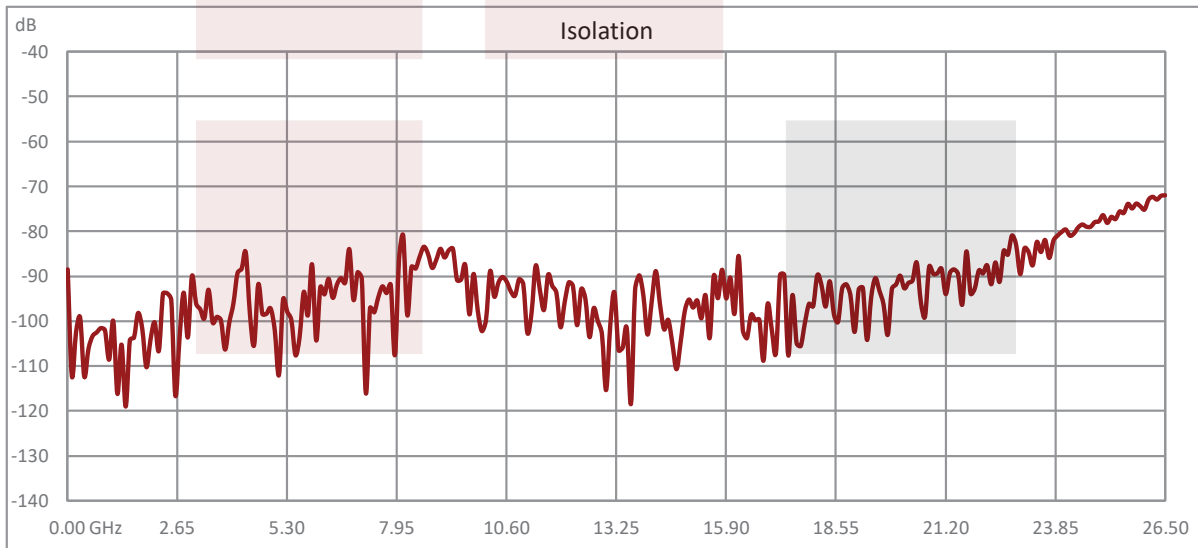

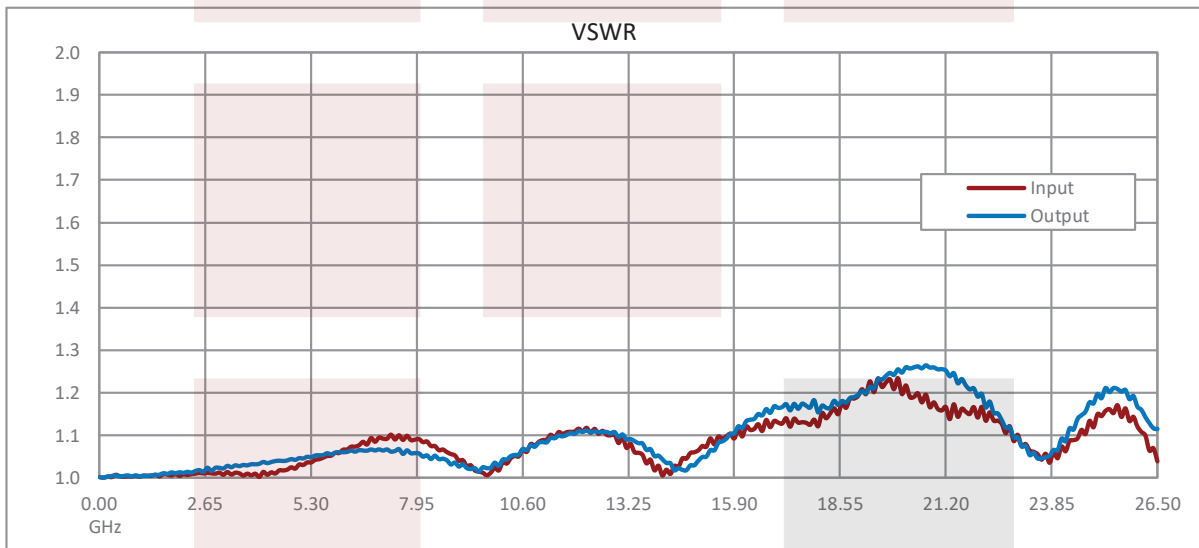
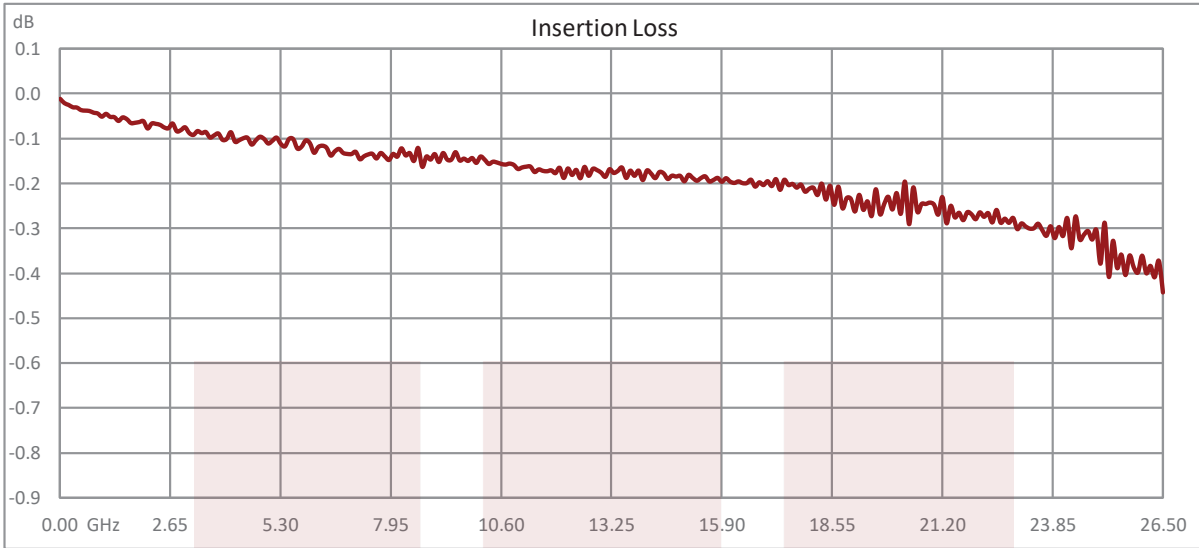

**Power Handling vs. Frequency**

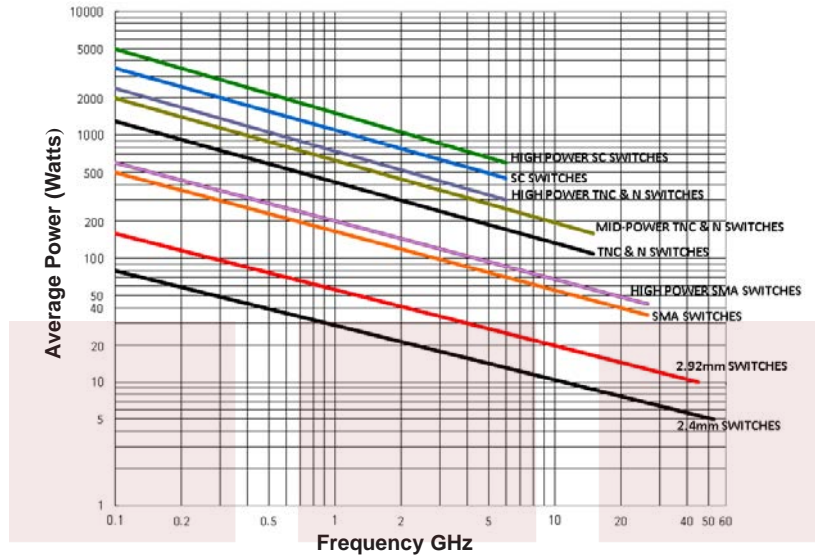

**Power Handling De-rating vs. Load VSWR**

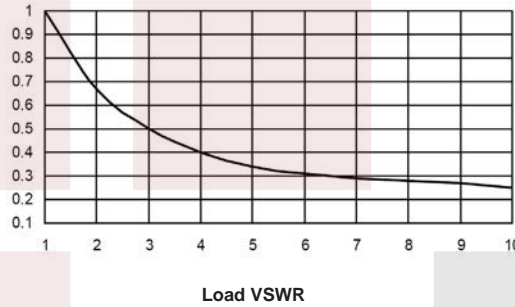

Power Handling Chart and Derating Curves based on the following Test and Environmental Conditions:  
 Ambient temperature: 20 - 25°C  
 Altitude: Sea Level to 1,000 feet  
 Relative Humidity: 50 - 55%  
 Load VSWR: ≤ 1.20:1  
 Operation: Cold Switching

SP4T E-M Relay Latching Switch, Self Cut-Off, Terminated, DC to 26.5 GHz, 90W, 5M Lifecycles, 28V, Indicators, TTL, Suppression Diodes, SMA from Fairview Microwave is in-stock and available to ship same-day. All of our RF/microwave products are available off-the-shelf from our ISO 9001:2008 certified facilities in Lewisville, Texas. Fairview Microwave is RF on-demand.

For additional information on this product, please click the following link: [SP4T E-M Relay Latching Switch, Self Cut-Off, Terminated, DC to 26.5 GHz, 90W, 5M Lifecycles, 28V, Indicators, TTL, Suppression Diodes, SMA FMSW6474](#)

URL: <https://www.fairviewmicrowave.com/sp4t-latching-26.5-ghz-terminated-electro-mechanical-relay-switch-indicators-28v-sma-fmsw6474-p.aspx>

The information contained in this document is accurate to the best of our knowledge and representative of the part described herein. It may be necessary to make modifications to the part and/or the documentation of the part, in order to implement improvements. Fairview Microwave reserves the right to make such changes as required. Unless otherwise stated, all specifications are nominal. Fairview Microwave does not make any representation or warranty regarding the suitability of the part described herein for any particular purpose, and Fairview Microwave does not assume any liability arising out of the use of any part or documentation.

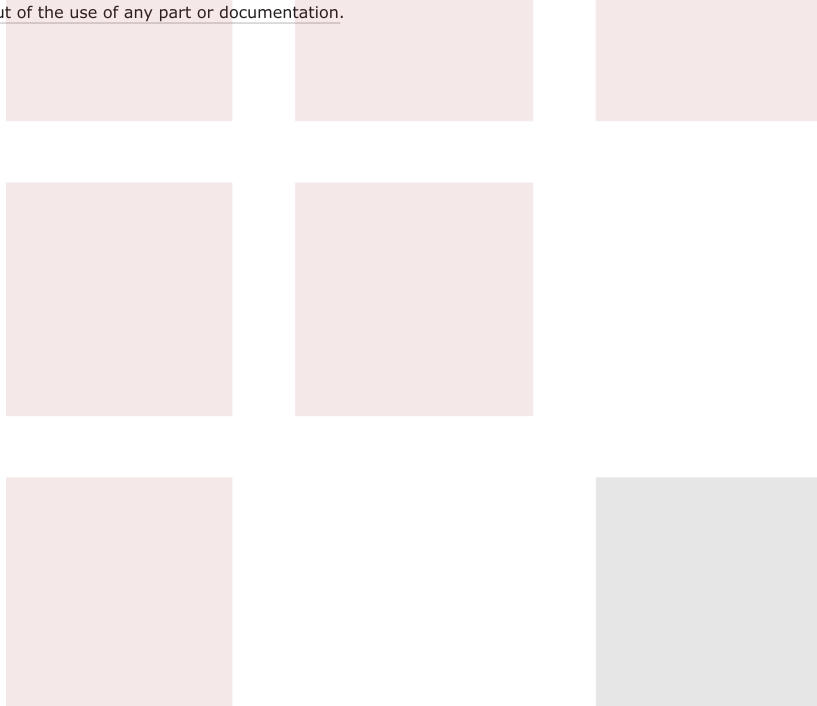

REVISIONS			
REV.	DESCRIPTION	DATE	APPROVED
A	INITIAL RELEASE	2/1/2021	T.GALLA

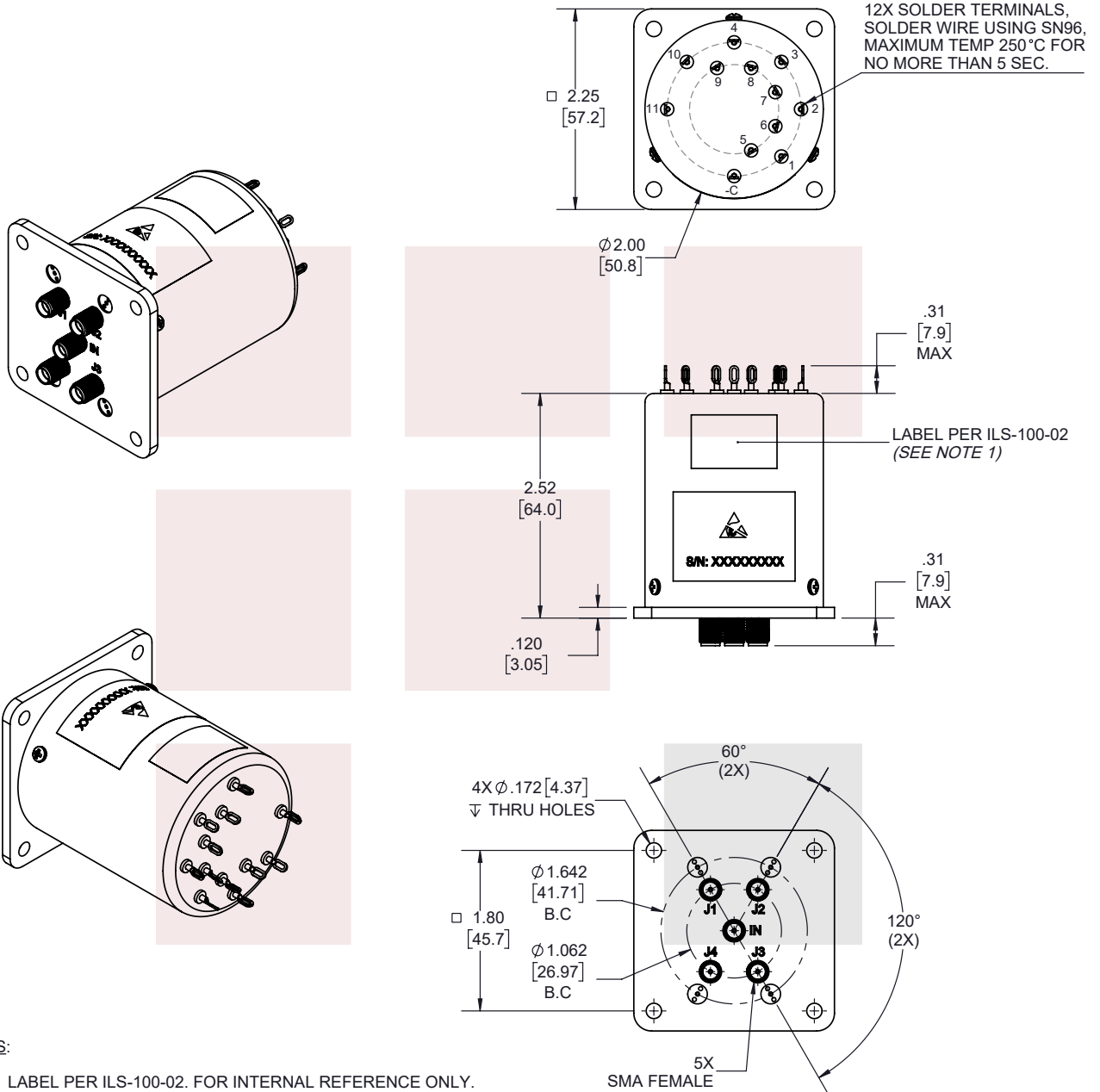

**NOTES:**

1. LABEL PER ILS-100-02. FOR INTERNAL REFERENCE ONLY. LABEL LOCATION FOR REFERENCE ONLY.

THESE COMMODITIES, TECHNOLOGY OR SOFTWARE WERE EXPORTED FROM THE UNITED STATES IN ACCORDANCE WITH THE EXPORT ADMINISTRATION REGULATIONS. DIVERSION CONTRARY TO U.S. LAW PROHIBITED.

TITLE  
SP4T E-M Relay Latching Switch, Self Cut-Off, Terminated, DC to 26.5 GHz, 90W, 5M Lifecycles, 28V, Indicators, TTL, Suppression Diodes, SMA

UNLESS OTHERWISE SPECIFIED LEADING DIMENSIONS ARE INCHES  
DIMENSIONS IN [ ] ARE MILLIMETERS

**TOLERANCES:**

.X = ±.2 [5.08] FRACTIONS ± 1/32  
.XX = ±.02 [.51] ANGLES ± 1°  
.XXX = ±.005 [.13]

**CABLE LENGTH (L) TOLERANCES:**

L ≤ 12 [305] = +1 [25] / -0  
12 [305] < L ≤ 60 [1524] = +2 [51] / -0  
60 [1524] < L ≤ 120 [3048] = +4 [102] / -0  
120 [3048] < L ≤ 300 [7620] = +6 [152] / -0  
300 [7620] < L = +5%L / -0

THIRD-ANGLE PROJECTION

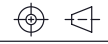

THE INFORMATION AND DESIGN IN THIS DOCUMENT IS THE PROPERTY OF FAIRVIEW MICROWAVE CORPORATION. ALL RIGHTS RESERVED.

SHEET 1 OF 2

ALL DIMENSIONS SHOWN ARE FOR REFERENCE ONLY.

SCALE N/A

SIZE A	CAGE CODE 3FKR5	DRAWN BY K.DANG	ITEM NO. FMSW6474	REV A
-----------	--------------------	--------------------	----------------------	----------

T-Rev.D

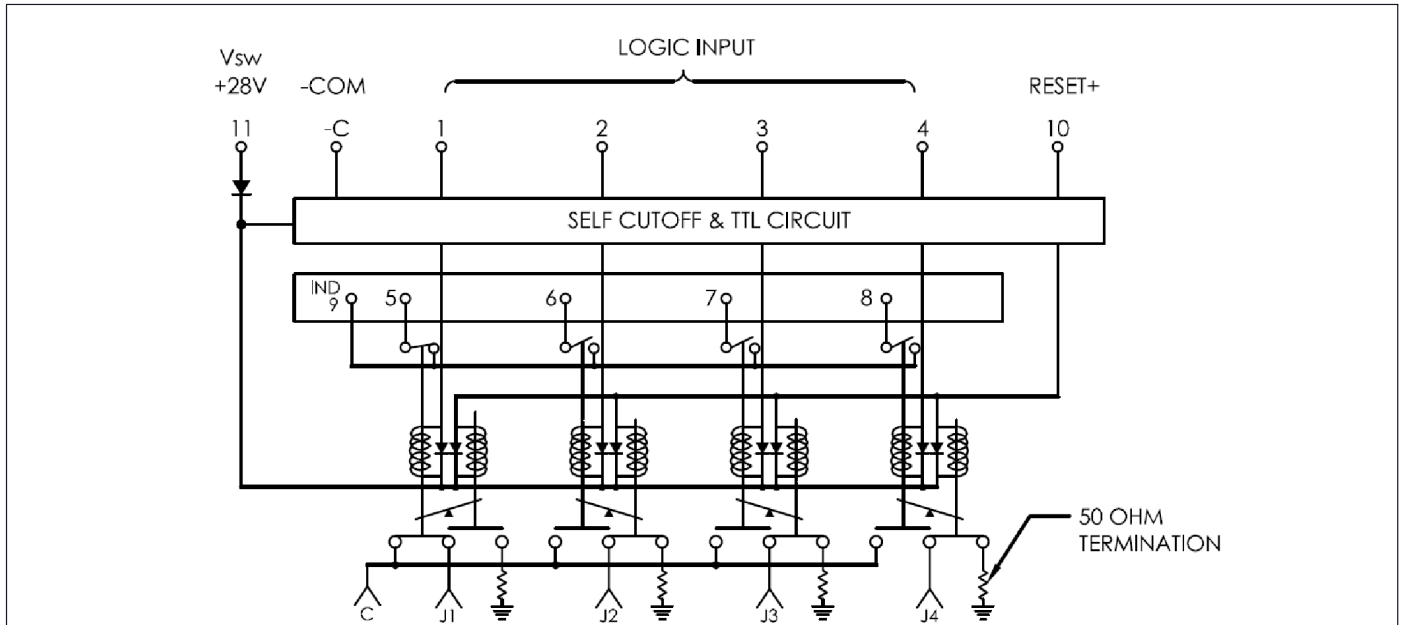

**SCHEMATIC**

(COIL 1 SHOWN LAST ENERGIZED)

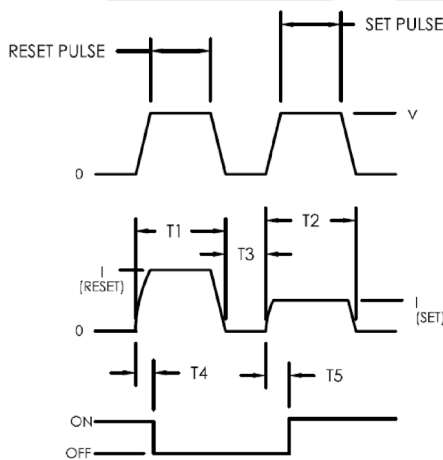

**PIN ASSIGNMENT**

TERMINALS LOGIC INPUT PINS	RF PATH				INDICATOR			
	J1	J2	J3	J4	5	6	7	8
1 ("1")	ON	OFF	OFF	OFF	ON	OFF	OFF	OFF
2 ("1")	OFF	ON	OFF	OFF	OFF	ON	OFF	OFF
3 ("1")	OFF	OFF	ON	OFF	OFF	OFF	ON	OFF
4 ("1")	OFF	OFF	OFF	ON	OFF	OFF	OFF	ON
10 ("1")	ALL OFF							

PIN -C, -COM  
PIN 9, IND COM  
PIN 11, V<sub>sw</sub> +28V

**ACTUATION CHARACTERISTICS:**

- REQUIRES TWO (2) SEQUENTIAL PULSES (RESET & SET)
- T1 & T2 = 30mSEC MIN.
- T3 = 10mSEC MIN.
- T4 & T5 = 20mSEC MAX.

THESE COMMODITIES, TECHNOLOGY OR SOFTWARE WERE EXPORTED FROM THE UNITED STATES IN ACCORDANCE WITH THE EXPORT ADMINISTRATION REGULATIONS. DIVERSION CONTRARY TO U.S. LAW PROHIBITED.

TITLE  
SP4T E-M Relay Latching Switch, Self Cut-Off,  
Terminated, DC to 26.5 GHz, 90W, 5M Lifecycles, 28V,  
Indicators, TTL, Suppression Diodes, SMA

UNLESS OTHERWISE SPECIFIED LEADING DIMENSIONS ARE INCHES  
DIMENSIONS IN [ ] ARE MILLIMETERS

**TOLERANCES:**

.X = ±.2 [5.08] FRACTIONS  
.XX = ±.02 [.51] ± 1/32  
.XXX = ±.005 [.13] ANGLES ± 1°

**CABLE LENGTH (L) TOLERANCES:**

L ≤ 12 [305] = +1 [25] / -0  
12 [305] < L ≤ 60 [1524] = +2 [51] / -0  
60 [1524] < L ≤ 120 [3048] = +4 [102] / -0  
120 [3048] < L ≤ 300 [7620] = +6 [152] / -0  
300 [7620] < L = +5%L / -0

**THIRD-ANGLE PROJECTION**

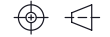

THE INFORMATION AND DESIGN IN THIS DOCUMENT IS THE PROPERTY OF FAIRVIEW MICROWAVE CORPORATION. ALL RIGHTS RESERVED.

SHEET 2 OF 2

SCALE N/A

ALL DIMENSIONS SHOWN ARE FOR REFERENCE ONLY.

SIZE A	CAGE CODE 3FKR5	DRAWN BY K.DANG	ITEM NO. FMSW6474	REV A
-----------	--------------------	--------------------	----------------------	----------

T-Rev.D