

SPDT Electromechanical Relay Latching Switch, DC to 12.4 GHz, 2M lifecycles, 160 Watts, 12V, TTL, Diodes, Self Cut Off, N, Solder Pins

The FMSW6493 is a Single Pole Double Throw (SPDT) electromechanical relay switch that operates across a wide frequency range from DC to 12 GHz and can handle up to 160 Watts of average power in a break before make condition. The 50 Ohm design is rated for 2 million lifecycles and features a Latching Self Cut-Off Actuator that magnetically latches in place after the control voltage is removed. For power sensitive applications, this is the best actuator option. Additional features include TTL control logic, and suppression diodes which limit voltage spikes or reverse current. Impressive typical performance includes 0.2 dB insertion loss and isolation greater than 90 dB. This switch requires +12Vdc bias voltage and operates over a temperature range of -25°C to +65°C. The rugged and compact package assembly supports N Type female connectors and Solder Pins for DC command control functions. And for highly reliable operation, the model is guaranteed to meet MIL-STD-202 environmental test conditions for shock and random vibration.

Electrical Specifications (TA = +25°C, DC Voltage = +12 Vdc)

Switch Type	SPDT
Actuator Type	Latching
Actuator Options	TTL Logic, Self Cut Off
TTL Control	on: 2.4 to 5.5 Volts off: 0 to 0.8 Volts

Description	Min	Typ	Max	Units
Frequency Range	DC		12.4	GHz
Operating Voltage		+12		Volts
Actuating Current @ +12 Volts			200	mA
VSWR		1.2:1	1.4:1	
Insertion Loss		0.2	0.5	dB
Isolation	60	90		dB
Input Power (CW) (at 12.4 GHz)			160	Watts

Performance by Frequency

Description	F1	F2	F3	F4	F5	Units
Frequency Range	DC - 1	1 - 4	4 - 8	8 - 12		GHz
VSWR, Max	1.25:1	1.3:1	1.4:1	1.4:1		
Insertion Loss, Max	0.3	0.4	0.4	0.5		dB
Isolation, Min	90	80	70	60		dB

Mechanical Specifications

Size	
Length	1.95 in [49.53 mm]
Width/Diameter	2.75 in [69.85 mm]
Height	0.92 in [23.37 mm]
Weight	0.4 lbs [181.44 g]



Features:

- Single Pole Double Throw (SPDT) Electromechanical Relay Switch
- DC to 12 GHz Frequency Range
- Latching Self Cut-Off Actuator
- TTL Logic Control
- Suppression Diodes
- 2M Lifecycle Rating
- Insertion Loss 0.2 dB typ
- Isolation > 90 dB typ
- VSWR as low as 1.25:1 max
- +12 Volt DC Bias
- Solder Terminal Pins for DC Command Control
- N Type Female Connectors
- -25°C to +65°C Operating Temperature
- Up to 160 Watt Average Power Handling
- 50 Ohm Design
- Hot Switching Capability - Consult Factory
- S-Parameter Data available upon request
- Rugged Design meets Mil-STD-202 Test Conditions

Applications:

- Aerospace & Defense
- Test & Measurement
- Microwave Radio Systems
- Military & Commercial Communication Systems
- Research & Development
- SATCOM
- Wireless Communications
- Enterprise
- IoT

Fairview Microwave
301 Leora Ln., Suite 100
Lewisville, TX 75056
Tel: 1-800-715-4396 / (972) 649-6678
Fax: (972) 649-6689
www.fairviewmicrowave.com
sales@fairviewmicrowave.com

Connectors

RF Connector Type N Female

Environmental Specifications

Temperature

Operating Range -25 to +65 deg C
Storage Range -55 to +100 deg C

Shock MIL-STD-202 Method 213, Condition D, 500G (non oper)
Vibration MIL-STD-202 Method 204, Condition D, 10G RMS (non oper)

Compliance Certifications (see [product page](#) for current document)

Plotted and Other Data

Notes:

Typical Performance Data

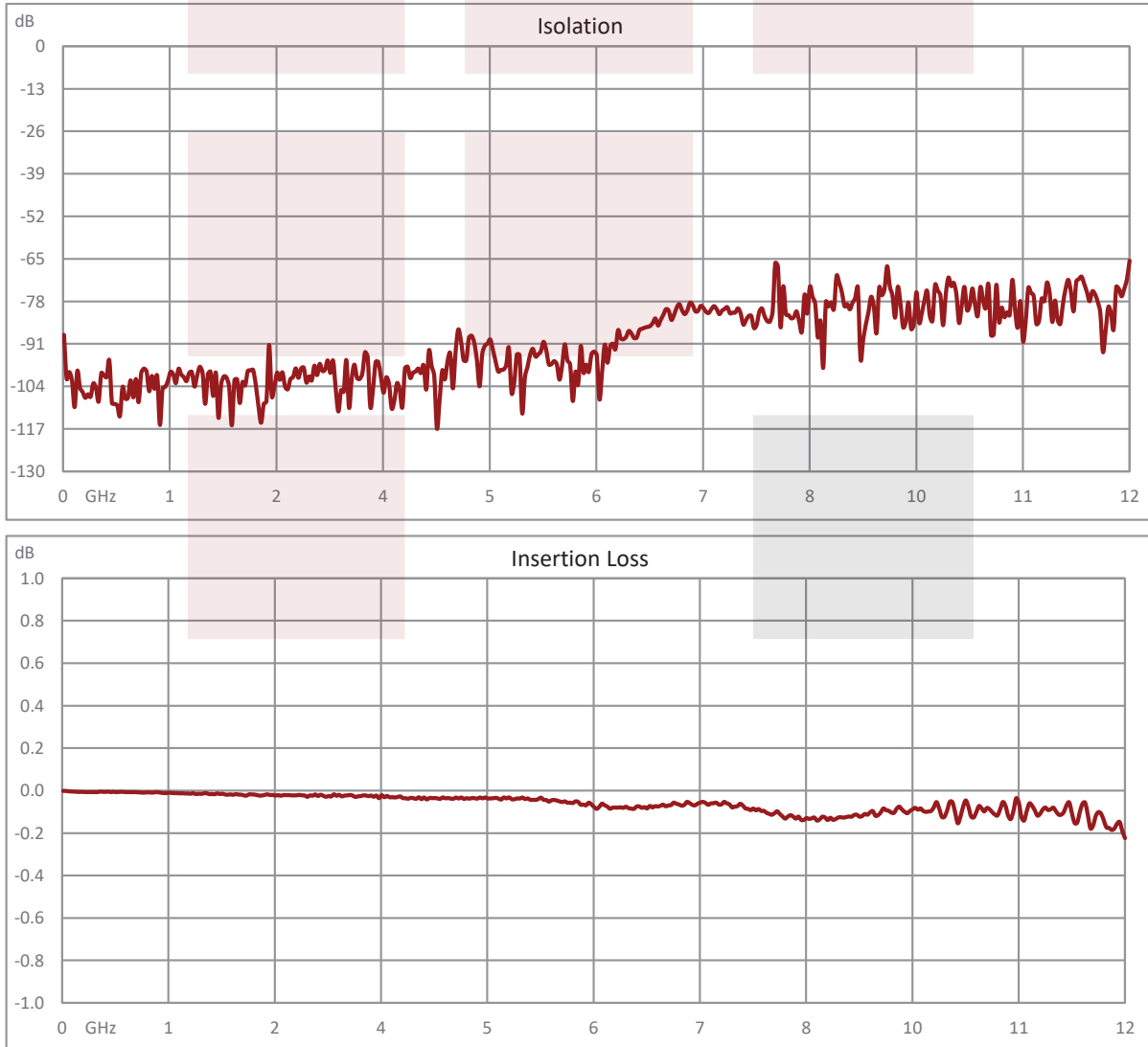

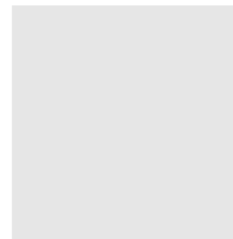
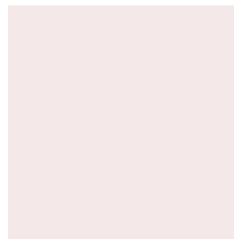
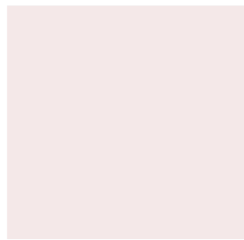
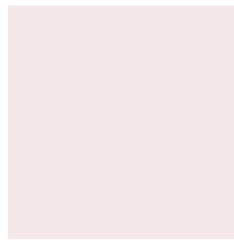
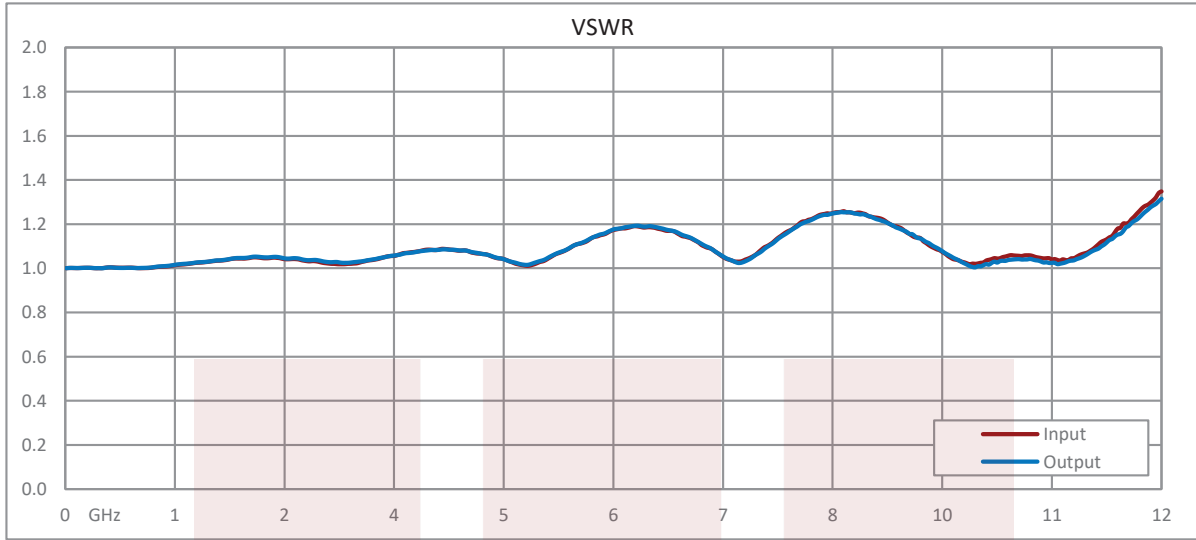

Power Handling vs. Frequency

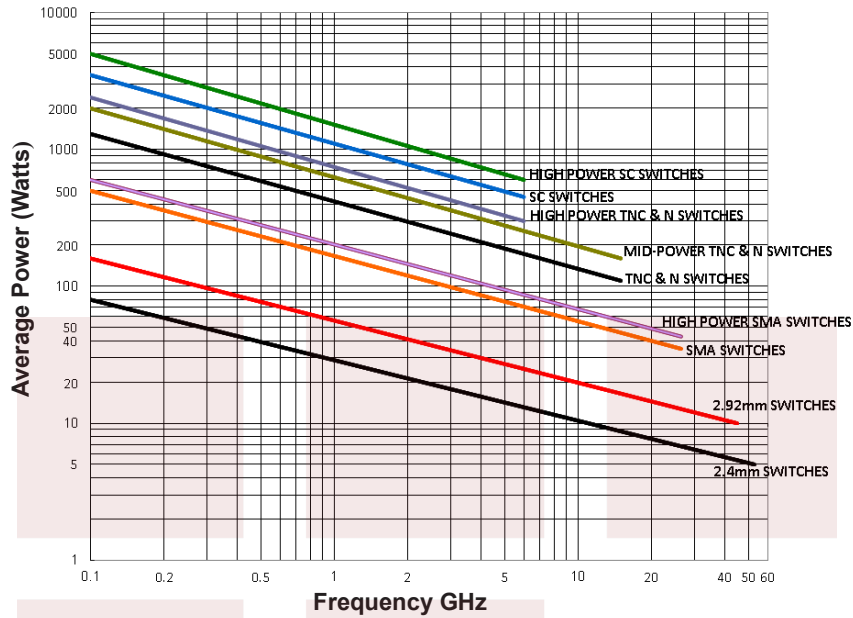

Power Handling De-rating vs. Load VSWR



Power Handling Chart and Derating Curves based on the following Test and Environmental Conditions:
 Ambient temperature: 20-25°C
 Altitude: Sea Level to 1,000 feet
 Relative Humidity: 50-55%
 Load VSWR: ≤ 1.20:1
 Operation: Cold Switching

SPDT Electromechanical Relay Latching Switch, DC to 12.4 GHz, 2M lifecycles, 160 Watts, 12V, TTL, Diodes, Self Cut Off, N, Solder Pins from Fairview Microwave is in-stock and available to ship same-day. All of our RF/microwave products are available off-the-shelf from our ISO 9001:2008 certified facilities in Lewisville, Texas. Fairview Microwave is RF on-demand.

For additional information on this product, please click the following link: [SPDT Electromechanical Relay Latching Switch, DC to 12.4 GHz, 2M lifecycles, 160 Watts, 12V, TTL, Diodes, Self Cut Off, N, Solder Pins FMSW6493](#)

URL: <https://www.fairviewmicrowave.com/spdt-latching-12.4-ghz-electro-mechanical-relay-switch-ttl-160w-12v-n-fm-sw6493-p.aspx>

The information contained in this document is accurate to the best of our knowledge and representative of the part described herein. It may be necessary to make modifications to the part and/or the documentation of the part, in order to implement improvements. Fairview Microwave reserves the right to make such changes as required. Unless otherwise stated, all specifications are nominal. Fairview Microwave does not make any representation or warranty regarding the suitability of the part described herein for any particular purpose, and Fairview Microwave does not assume any liability arising out of the use of any part or documentation.

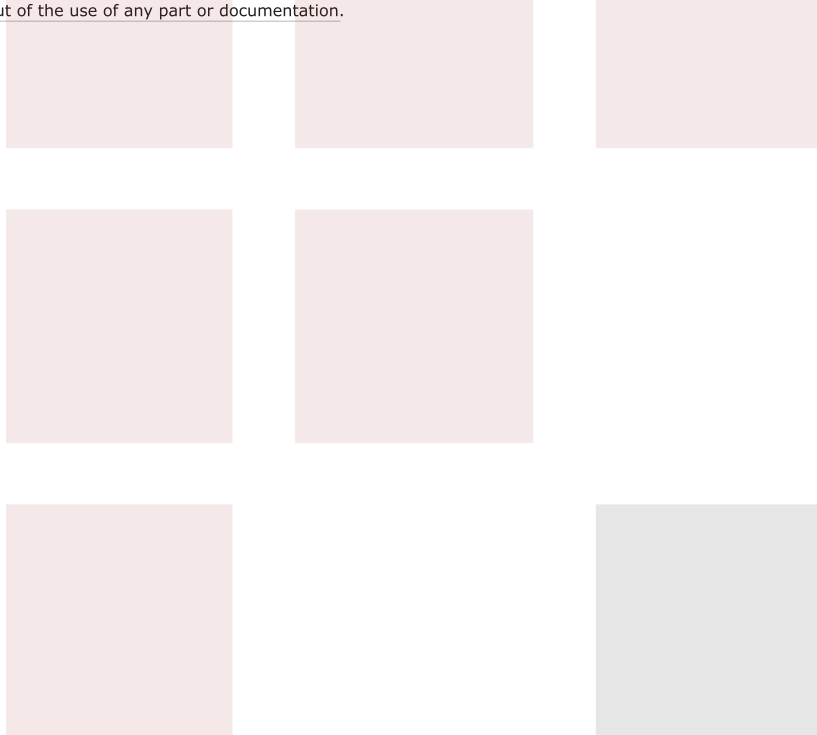

REVISIONS			
REV.	DESCRIPTION	DATE	APPROVED
A	INITIAL RELEASE	05/19/2022	T.GALLA

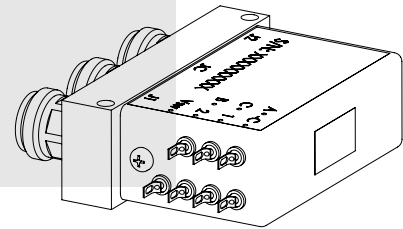
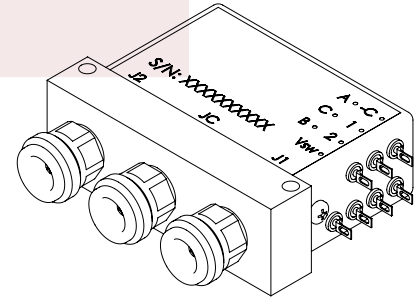
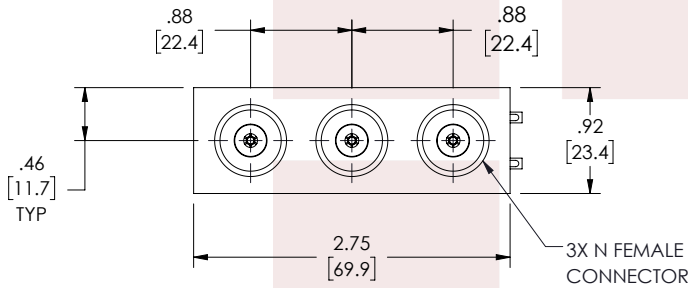
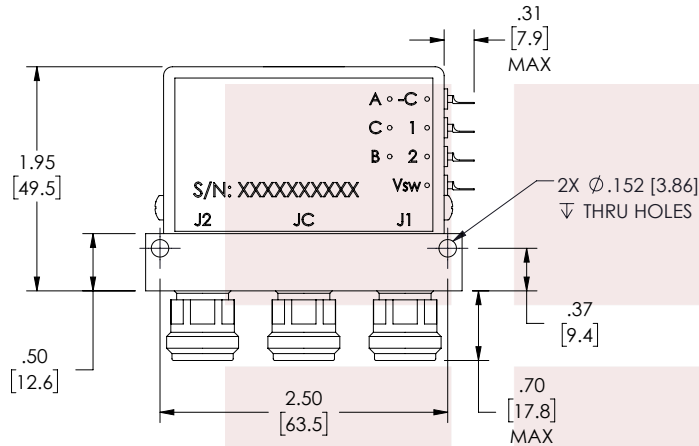
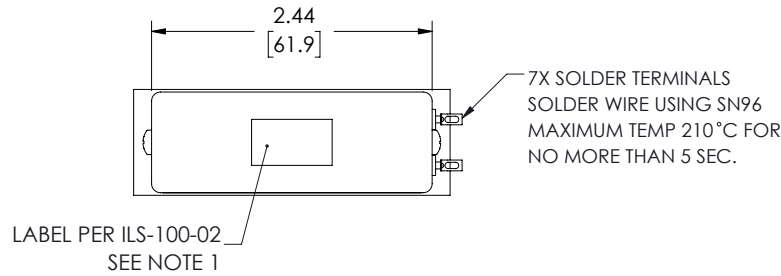

- NOTES:
- LABEL PER ILS-100-02. FOR INTERNAL REFERENCE ONLY.
LABEL LOCATION FOR REFERENCE ONLY.

THESE COMMODITIES, TECHNOLOGY OR SOFTWARE WERE EXPORTED FROM THE UNITED STATES IN ACCORDANCE WITH THE EXPORT ADMINISTRATION REGULATIONS. DIVERSION CONTRARY TO U.S. LAW PROHIBITED.

TITLE
SPDT Electromechanical Relay Latching Switch, DC to 12.4 GHz, 2M lifecycles, 160 Watts, 12V, TTL, Diodes, Self Cut Off, N, Solder Pins

UNLESS OTHERWISE SPECIFIED LEADING DIMENSIONS ARE INCHES
DIMENSIONS IN [] ARE MILLIMETERS

TOLERANCES: CABLE LENGTH (L) TOLERANCES:

.X = ±.2 [5.08]	FRACTIONS	L ≤ 12 [305] = +1 [25] / -0
.XX = ±.02 [.51]	± 1/32	12 [305] < L ≤ 60 [1524] = +2 [51] / -0
.XXX = ±.005 [.13]	ANGLES ± 1°	60 [1524] < L ≤ 120 [3048] = +4 [102] / -0
		120 [3048] < L ≤ 300 [7620] = +6 [152] / -0
		300 [7620] < L = +5%L / -0

THIRD-ANGLE PROJECTION



THE INFORMATION AND DESIGN IN THIS DOCUMENT IS THE PROPERTY OF FAIRVIEW MICROWAVE CORPORATION. ALL RIGHTS RESERVED.

SHEET 1 OF 2

ALL DIMENSIONS SHOWN ARE FOR REFERENCE ONLY.

SCALE N/A

SIZE A	CAGE CODE 3FKR5	DRAWN BY KGLEBOVA	ITEM NO. FMSW6493	REV A
-----------	--------------------	----------------------	----------------------	----------

T-Rev.D

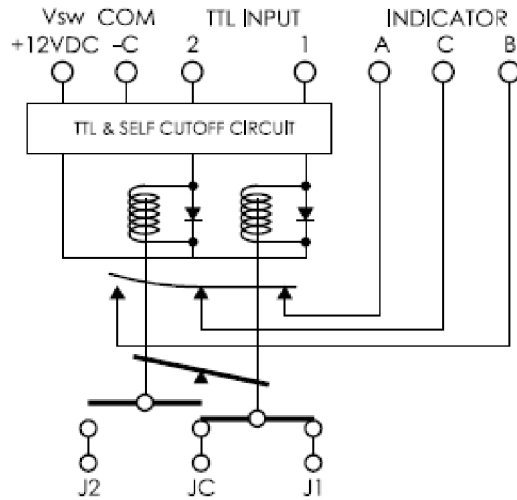

SCHEMATIC

OPERATIONAL LOGIC TABLE					
TERMINALS		RF PORTS		INDICATOR	
1	2	J1	J2	A-C	B-C
0	0	NO CHANGE		NO CHANGE	
0	1	OFF	ON	OFF	ON
1	0	ON	OFF	ON	OFF
1	1	FORBIDDEN		FORBIDDEN	



THESE COMMODITIES, TECHNOLOGY OR SOFTWARE WERE EXPORTED FROM THE UNITED STATES IN ACCORDANCE WITH THE EXPORT ADMINISTRATION REGULATIONS. DIVERSION CONTRARY TO U.S. LAW PROHIBITED.

TITLE
SPDT Electromechanical Relay Latching Switch, DC to 12.4 GHz, 2M lifecycles, 160 Watts, 12V, TTL, Diodes, Self Cut Off, N, Solder Pins

UNLESS OTHERWISE SPECIFIED LEADING DIMENSIONS ARE INCHES
DIMENSIONS IN [] ARE MILLIMETERS

TOLERANCES:		CABLE LENGTH (L) TOLERANCES:	
.X = ±.2 [.51]	FRACTIONS ± 1/32	L ≤ 12 [305] = +1 [25] / -0	
.XX = ±.02 [.51]		12 [305] < L ≤ 60 [1524] = +2 [51] / -0	
.XXX = ±.005 [.13]	ANGLES ± 1°	60 [1524] < L ≤ 120 [3048] = +4 [102] / -0	
		120 [3048] < L ≤ 300 [7620] = +6 [152] / -0	
		300 [7620] < L = +5%L / -0	

THIRD-ANGLE PROJECTION

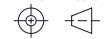

THE INFORMATION AND DESIGN IN THIS DOCUMENT IS THE PROPERTY OF FAIRVIEW MICROWAVE CORPORATION. ALL RIGHTS RESERVED.

SHEET 2 OF 2

ALL DIMENSIONS SHOWN ARE FOR REFERENCE ONLY.

SCALE N/A

SIZE A	CAGE CODE 3FKR5	DRAWN BY KGLEBOVA	ITEM NO. FMSW6493	REV A
--------	-----------------	-------------------	-------------------	-------

T-Rev.D