

SP6T Electromechanical Relay Normally Open Switch, Terminated, DC to 26.5 GHz, 2M lifecycles, 20W, 28V, SMA, Solder Pins

The FMSW6516 is a Single Pole Six Throw (SP6T) electromechanical relay switch that operates across a wide frequency range from DC to 26.5 GHz and can handle up to 20W of average power in a break before make condition. The 50 Ohm design is rated for 2 million lifecycles and features a Normally Open Actuator where the selected position remains active with constant voltage, all positions are open when voltage is removed. The output ports are terminated in 50 ohms when switched in the isolation (off) state. Impressive typical performance includes 0.4 dB insertion loss and isolation greater than 70 dB. This switch requires +28Vdc bias voltage and operates over a temperature range of -25°C to +65°C. The rugged and compact package assembly supports SMA female connectors and Solder Pins for DC control. And for highly reliable operation, the model is guaranteed to meet MIL-STD-202 environmental test conditions for shock and random vibration.

Electrical Specifications (TA = +25°C, DC Voltage = +28 Vdc)

Switch Type SP6T
Actuator Type Normally Open

Description	Min	Typ	Max	Units
Frequency Range	DC		26.5	GHz
Operating Voltage		+28		Volts
Actuating Current @ +28 Volts			200	mA
VSWR		1.2:1	1.8:1	
Insertion Loss		0.4	0.8	dB
Isolation	50	70		dB
Input Power (CW) (at 26.5 GHz)			20	Watts

Performance by Frequency

Description	F1	F2	F3	F4	F5	Units
Frequency Range	DC - 6	6 - 12	12 - 18	18 - 26.5		GHz
VSWR, Max	1.25:1	1.4:1	1.5:1	1.8:1		
Insertion Loss, Max	0.2	0.4	0.5	0.8		dB
Isolation, Min	70	60	60	50		dB

Mechanical Specifications

Size
 Length 2.52 in [64.01 mm]
 Width/Diameter 2.25 in [57.15 mm]
 Height 2.25 in [57.15 mm]
 Weight 0.4 lbs [181.44 g]

Connectors

RF Connector Type SMA Female



Features:

- Single Pole Six Throw (SP6T) Electromechanical Relay Switch
- DC to 26.5 GHz Frequency Range
- Normally Open Actuator
- 2M Lifecycle Rating
- Insertion Loss 0.4 dB typ
- Isolation > 70 dB typ
- VSWR as low as 1.25:1 max
- +28 Volt DC Bias
- Terminal Solder Pins for DC Control
- SMA Female Connectors
- -25°C to +65°C Operating Temperature
- Up to 20 Watt Average Power Handling
- 50 Ohm Design
- Hot Switching Capability - Consult Factory
- S-Parameter Data available upon request
- Rugged Design meets Mil-STD-202 Test Conditions

Applications:

- Aerospace & Defense
- Test & Measurement
- Microwave Radio Systems
- Military & Commercial Communication Systems
- Research & Development
- SATCOM
- Wireless Communications
- Enterprise
- IoT

Fairview Microwave
 301 Leora Ln., Suite 100
 Lewisville, TX 75056
 Tel: 1-800-715-4396 / (972) 649-6678
 Fax: (972) 649-6689
www.fairviewmicrowave.com
sales@fairviewmicrowave.com

Environmental Specifications

Temperature

Operating Range -25 to +65 deg C
Storage Range -55 to +100 deg C

Shock MIL-STD-202 Method 213, Condition D, 500G (non oper)
Vibration MIL-STD-202 Method 204, Condition D, 10G RMS (non oper)

Compliance Certifications (see [product page](#) for current document)

Plotted and Other Data

Notes:

Typical Performance Data

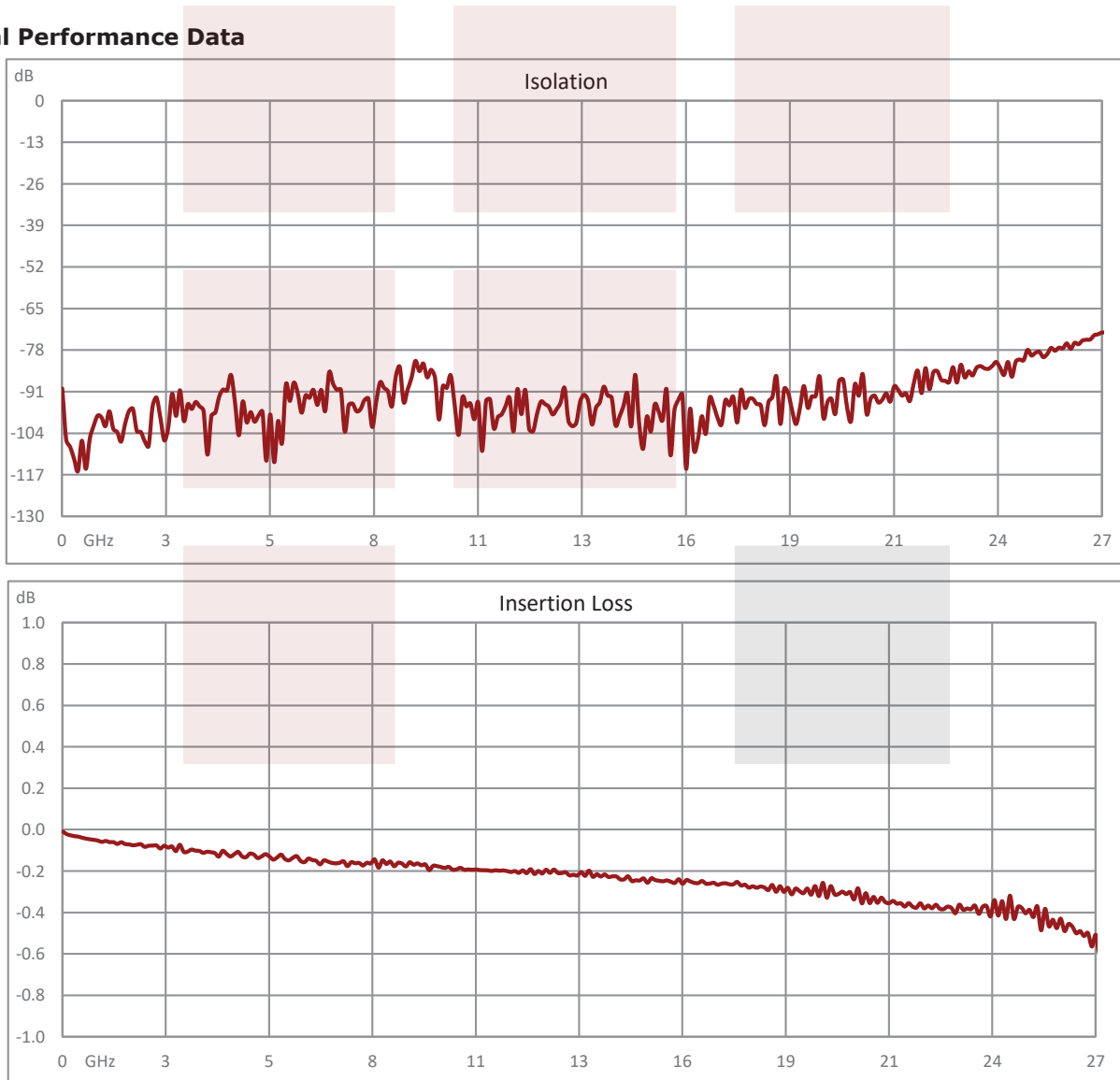

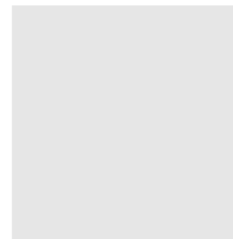
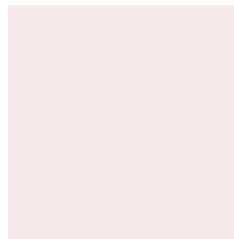
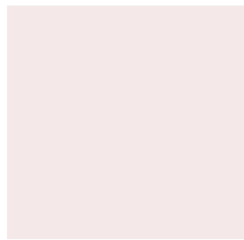
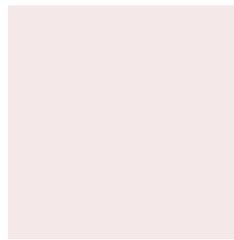
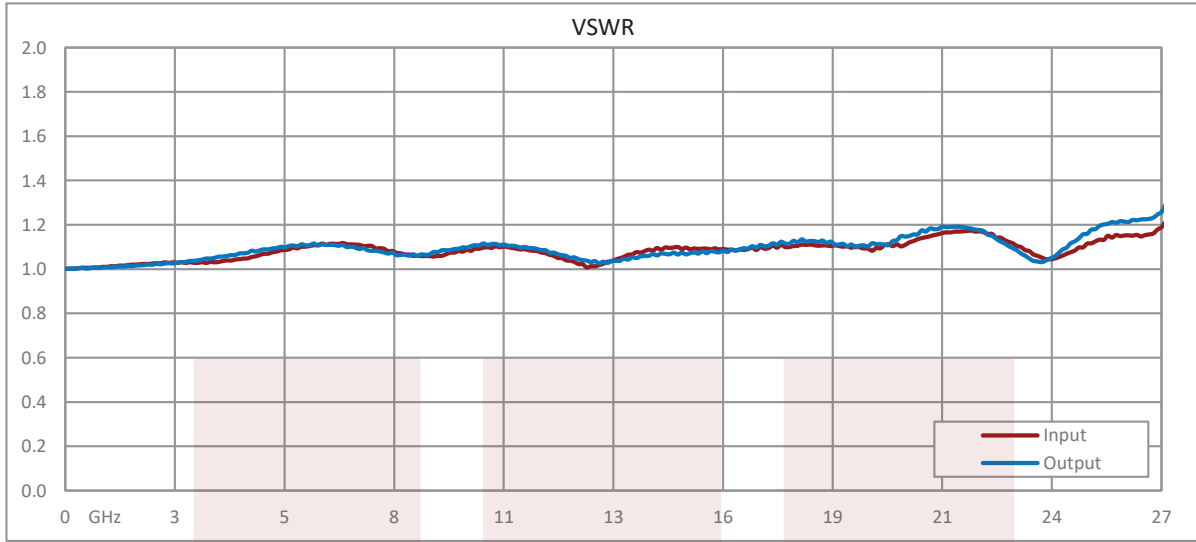

Power Handling vs. Frequency

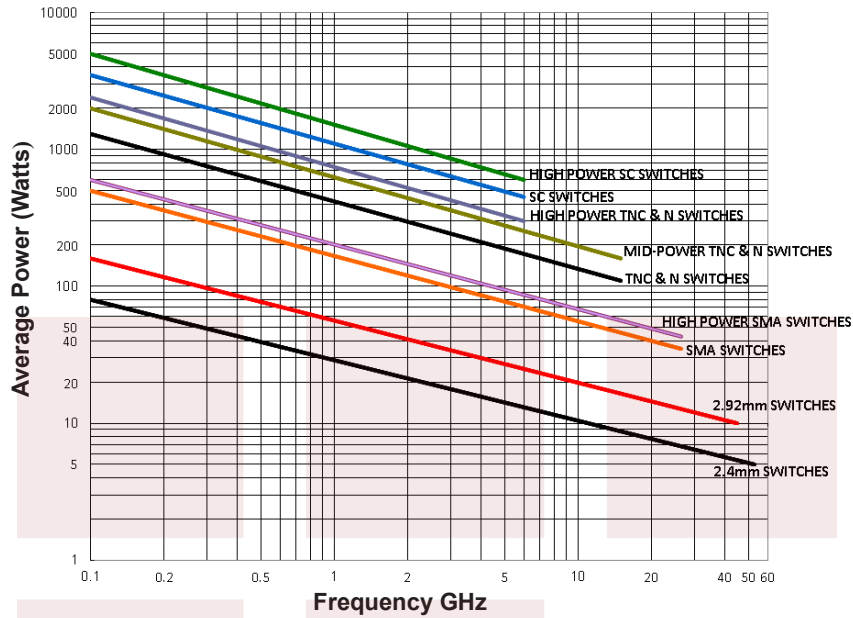

Power Handling De-rating vs. Load VSWR



Power Handling Chart and Derating Curves based on the following Test and Environmental Conditions:
 Ambient temperature: 20-25°C
 Altitude: Sea Level to 1,000 feet
 Relative Humidity: 50-55%
 Load VSWR: ≤ 1.20:1
 Operation: Cold Switching

SP6T Electromechanical Relay Normally Open Switch, Terminated, DC to 26.5 GHz, 2M lifecycles, 20W, 28V, SMA, Solder Pins from Fairview Microwave is in-stock and available to ship same-day. All of our RF/microwave products are available off-the-shelf from our ISO 9001:2008 certified facilities in Lewisville, Texas. Fairview Microwave is RF on-demand.

For additional information on this product, please click the following link: [SP6T Electromechanical Relay Normally Open Switch, Terminated, DC to 26.5 GHz, 2M lifecycles, 20W, 28V, SMA, Solder Pins FMSW6516](#)

URL: <https://www.fairviewmicrowave.com/sp6t-normally-open-26.5-ghz-electro-mechanical-relay-switch-20w-28v-sma-fmsw6516-p.aspx>

The information contained in this document is accurate to the best of our knowledge and representative of the part described herein. It may be necessary to make modifications to the part and/or the documentation of the part, in order to implement improvements. Fairview Microwave reserves the right to make such changes as required. Unless otherwise stated, all specifications are nominal. Fairview Microwave does not make any representation or warranty regarding the suitability of the part described herein for any particular purpose, and Fairview Microwave does not assume any liability arising out of the use of any part or documentation.



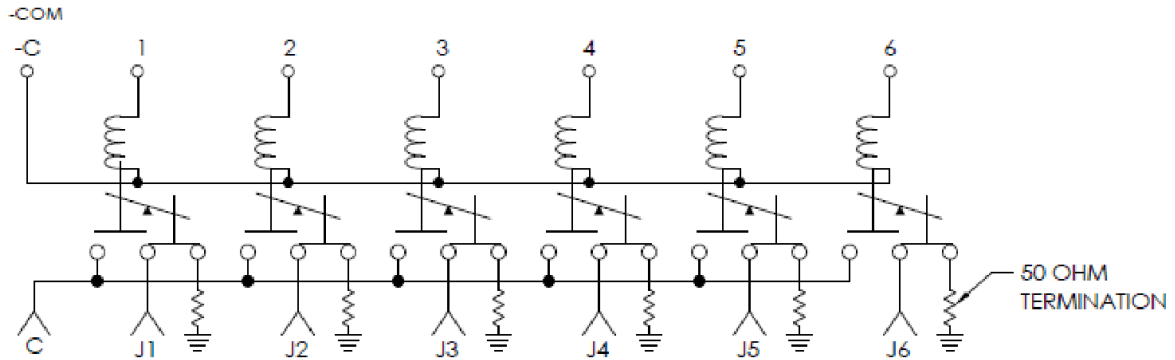

SCHEMATIC

(SHOWN IN NORMALLY OPEN AND INTERNALLY TERMINATE POSITIONS)

TRUTH TABLE/PIN ASSIGNMENT :
PIN ASSIGNMENT

TERMINALS PIN ASSIGNMENT	RF PATH					
	J1	J2	J3	J4	J5	J6
1	ON	OFF	OFF	OFF	OFF	OFF
2	OFF	ON	OFF	OFF	OFF	OFF
3	OFF	OFF	ON	OFF	OFF	OFF
4	OFF	OFF	OFF	ON	OFF	OFF
5	OFF	OFF	OFF	OFF	ON	OFF
6	OFF	OFF	OFF	OFF	OFF	ON

PIN -C. -COM

THESE COMMODITIES, TECHNOLOGY OR SOFTWARE WERE EXPORTED FROM THE UNITED STATES IN ACCORDANCE WITH THE EXPORT ADMINISTRATION REGULATIONS. DIVERSION CONTRARY TO U.S. LAW PROHIBITED.

TITLE

SP6T Electromechanical Relay Normally Open Switch,
Terminated, DC to 26.5 GHz, 2M lifecycles, 20W, 28V,
SMA, Solder Pins

UNLESS OTHERWISE SPECIFIED LEADING DIMENSIONS ARE INCHES
DIMENSIONS IN [] ARE MILLIMETERS

TOLERANCES: CABLE LENGTH (L) TOLERANCES:

.X = ±.2 [5.08]	FRACTIONS	L ≤ 12 [305] = +1 [25] / -0
.XX = ±.02 [.51]	± 1/32	12 [305] < L ≤ 60 [1524] = +2 [51] / -0
.XXX = ±.005 [.13]	ANGLES ± 1°	60 [1524] < L ≤ 120 [3048] = +4 [102] / -0
		120 [3048] < L ≤ 300 [7620] = +6 [152] / -0
		300 [7620] < L = +5%L / -0

THIRD-ANGLE PROJECTION



THE INFORMATION AND DESIGN IN THIS DOCUMENT IS THE PROPERTY OF FAIRVIEW MICROWAVE CORPORATION. ALL RIGHTS RESERVED.

SHEET 2 OF 2

ALL DIMENSIONS SHOWN ARE FOR REFERENCE ONLY.

SCALE

N/A

SIZE A	CAGE CODE 3FKR5	DRAWN BY KGLEBOVA	ITEM NO. FMSW6516	REV A
-----------	--------------------	----------------------	----------------------	----------

T-Rev.D