

SP4T, IP64 Rated Electromechanical Relay Latching Switch, DC to 18 GHz, 90W, 28VDC, SMA

The FMSW6548 is a Ruggedized SP4T electromechanical relay switch that operates across a broadband frequency range from DC to 18 GHz and can handle up to 90W of average power in a break before make condition. The 50 Ohm design is IP64 compliant with a Level 1 moisture seal and specifically designed to operate reliably in harsh usage environments and conditions, such as over extreme temperatures and wet or dusty environments. Intrusion protection offers full protection against dust and other particulates. Moisture protection enables resistance to splashes in all directions. The switch has a Latching Actuator that magnetically latches in place after the control voltage is removed. For power sensitive applications, this is the best actuator option. Impressive typical performance includes 0.2 dB insertion loss and isolation greater than 80 dB. This switch requires +28Vdc bias voltage, operates over a temperature range of -54°C to +85°C, and is rated for 5 million lifecycles. The rugged and compact package assembly supports SMA female connectors and a 15 pin D-Sub connector for DC control. And for highly reliable operation, the model is guaranteed to meet MIL-STD-202 environmental test conditions for shock and random vibration.



Features:

- SP4T Electromechanical Relay Switch
- IP64 Level 1 Rated
- DC to 18 GHz Frequency Range
- Latching Actuator
- 5M Lifecycle Rating
- Insertion Loss 0.2 dB typ
- Isolation > 80 dB typ
- VSWR as low as 1.25:1 max
- SMA Female Connectors
- +28 Volt DC Bias
- 15 Pin D-Sub Connector for DC Control
- -54°C to +85°C Operating Temperature
- Up to 90 Watt Average Power Handling
- 50 Ohm Design
- Hot Switching Capability - Consult Factory
- S-Parameter Data available upon request
- Rugged Design meets Mil-STD-202 Test Conditions
- Actuating Set/Reset Feature

Electrical Specifications (TA = +25°C, DC Voltage = 28 Vdc)

Description	Min	Typ	Max	Units
Switch Type	SP4T			
Actuator Type	Latching			
Frequency Range	DC		18	GHz
Impedance		50		Ohms
Operating Voltage	26	28	30	Volts
Actuating Current @ 28 Volts			110	mA
Actuating Reset Current			440	mA
VSWR		1.1:1	1.5:1	
Insertion Loss		0.2	0.5	dB
Isolation	80	90		dB
Switching Time		20		ms

Performance by Frequency

Description	F1	F2	F3	F4	F5	Units
Frequency Range	DC - 6	6 - 12	12 - 18			GHz
VSWR, Max	1.25:1	1.4:1	1.5:1			
Insertion Loss, Max	0.2	0.4	0.5			dB
Isolation, Min	80	80	80			dB

Mechanical Specifications

Size	
Length	1.75 in [44.45 mm]
Width/Diameter	1.75 in [44.45 mm]
Height	1.75 in [44.45 mm]
Weight	0.172 lbs [78.02 g]

Applications:

- Aerospace & Defense
- Test & Measurement
- Microwave Radio Systems
- Military & Commercial Communication Systems
- Research & Development
- SATCOM
- Wireless Communications
- Enterprise
- IoT

Fairview Microwave
 301 Leora Ln., Suite 100
 Lewisville, TX 75056
 Tel: 1-800-715-4396 / (972) 649-6678
 Fax: (972) 649-6689
www.fairviewmicrowave.com
sales@fairviewmicrowave.com

Connectors

RF Connector Type
Control Connector

SMA Female
D-Subminiature

Environmental Specifications

Temperature

Operating Range
Storage Range

-54 to +85 deg C
-55 to +100 deg C

Ingress Protection (IP) Rating

IP64

Shock

MIL-STD-202 Method 213, Condition D, 500 G (non oper)

Vibration

MIL-STD-202 Method 204, Condition D, 10G RMS (non oper)

Compliance Certifications (see [product page](#) for current document)

Plotted and Other Data

Notes:

Typical Performance Data

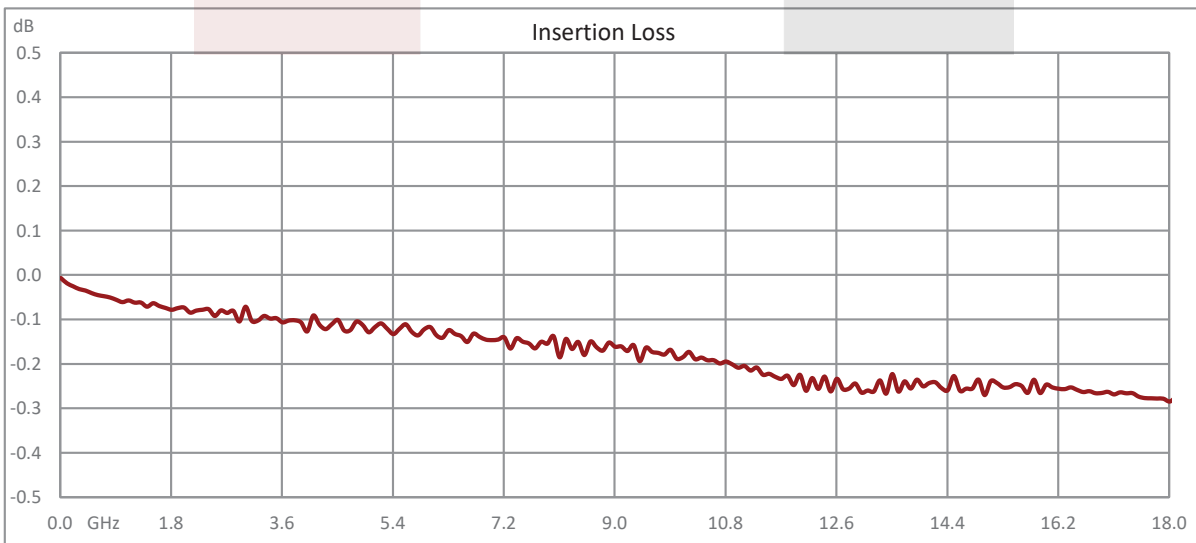
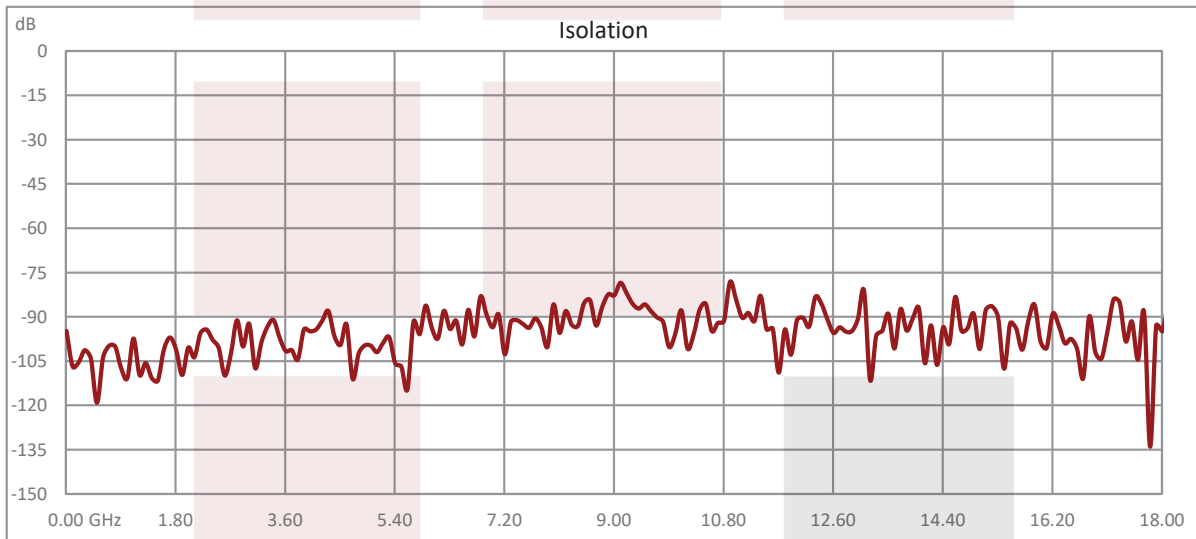

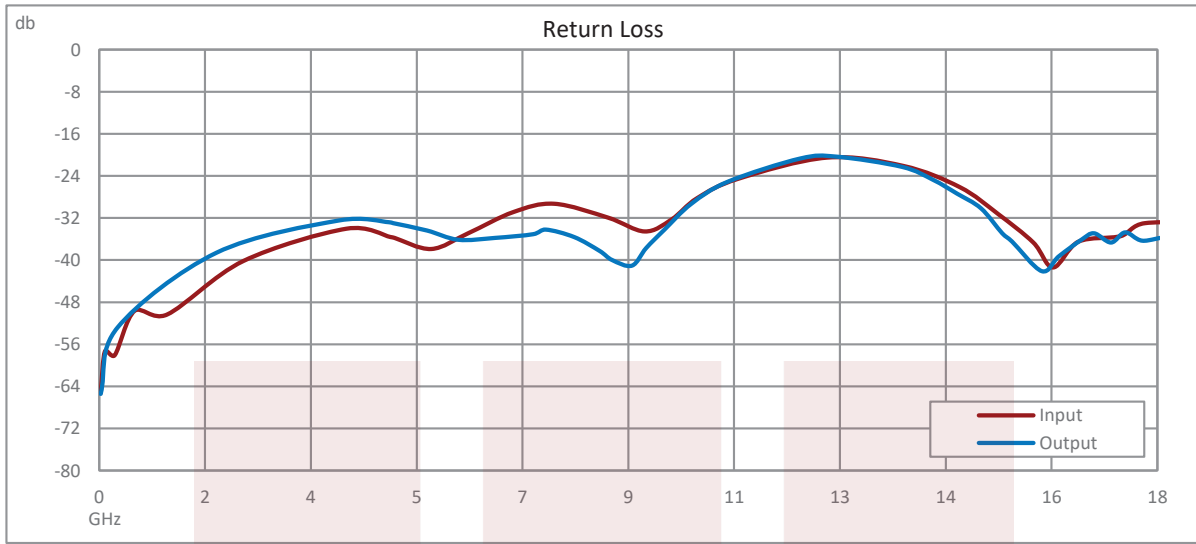

Power Handling vs. Frequency

Power Handling vs. Frequency

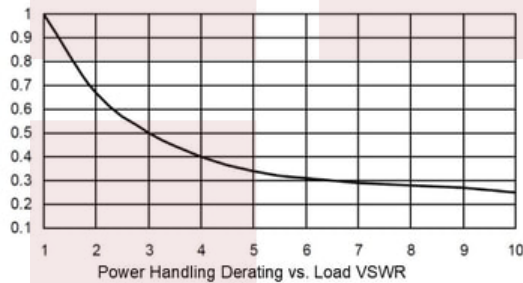
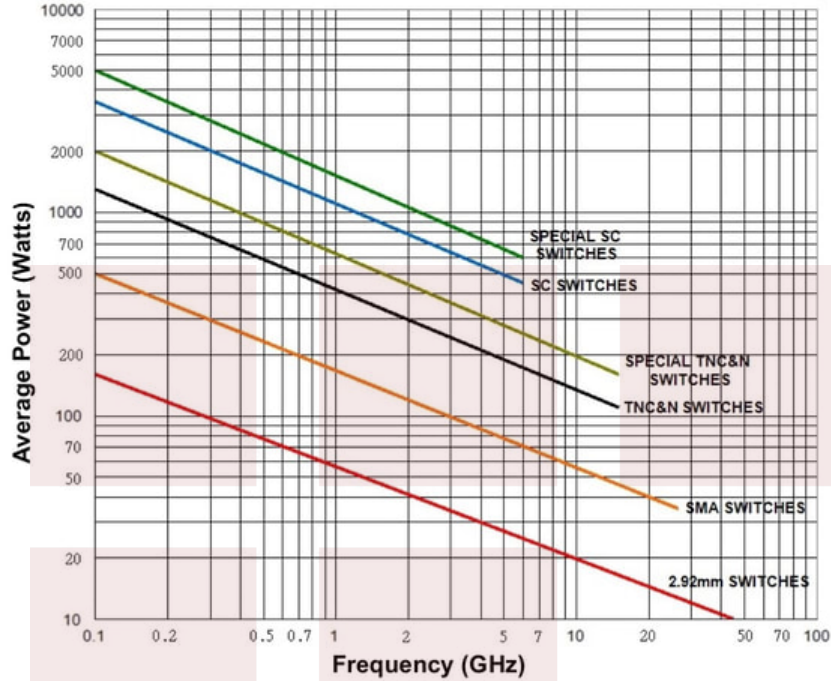

Power handling chart and derating curves based on the following conditions:

- Ambient temperature: 40°C or less
- Altitude: Sea level
- Load VSWR: 1.20:1 Maximum
- Relative Humidity: 40-50%
- Cold switching: RF signal off

Note: specifications subject to change without notice

SP4T, IP64 Rated Electromechanical Relay Latching Switch, DC to 18 GHz, 90W, 28VDC, SMA from Fairview Microwave is in-stock and available to ship same-day. All of our RF/microwave products are available off-the-shelf from our ISO 9001:2008 certified facilities in Lewisville, Texas. Fairview Microwave is RF on-demand.

For additional information on this product, please click the following link: [SP4T, IP64 Rated Electromechanical Relay Latching Switch, DC to 18 GHz, 90W, 28VDC, SMA FMSW6548](#)

URL: <https://www.fairviewmicrowave.com/sp4t-latching-18-ghz-electro-mechanical-relay-switch-sma-fmsw6548-p.aspx>

The information contained in this document is accurate to the best of our knowledge and representative of the part described herein. It may be necessary to make modifications to the part and/or the documentation of the part, in order to implement improvements. Fairview Microwave reserves the right to make such changes as required. Unless otherwise stated, all specifications are nominal. Fairview Microwave does not make any representation or warranty regarding the suitability of the part described herein for any particular purpose, and Fairview Microwave does not assume any liability arising out of the use of any part or documentation.

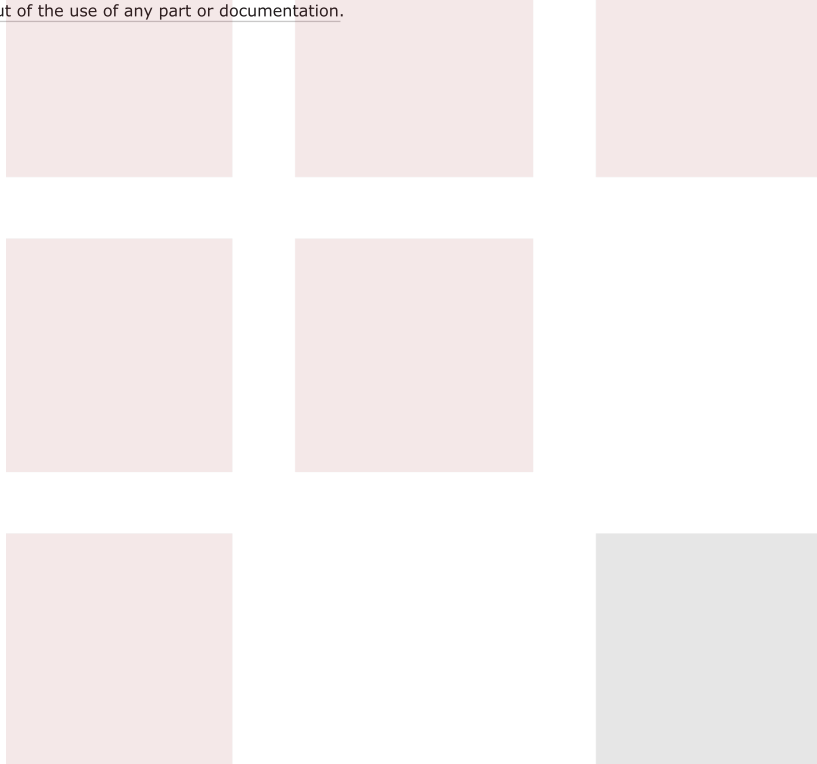

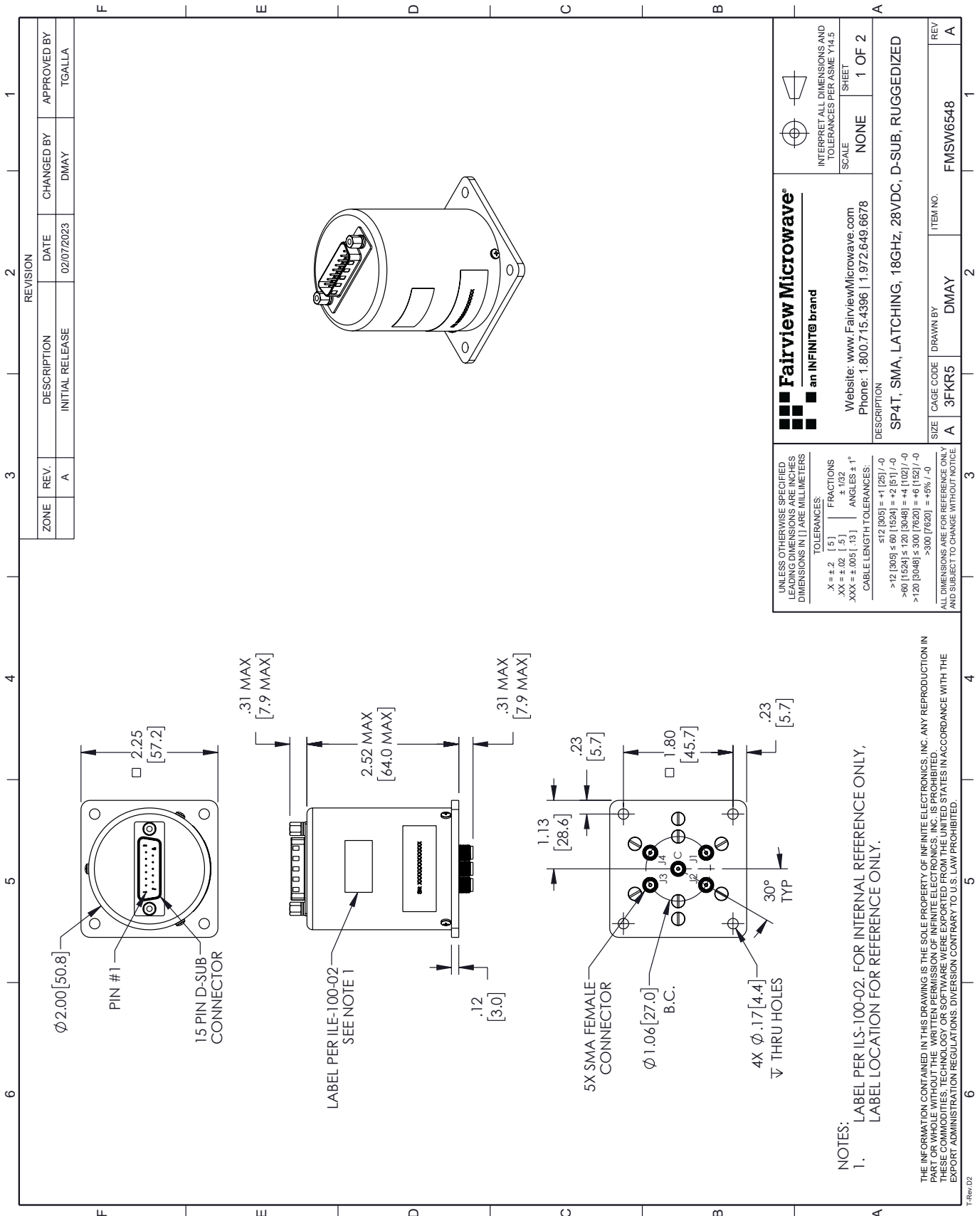

NOTES:
1. LABEL PER ILS-100-02, FOR INTERNAL REFERENCE ONLY, LABEL LOCATION FOR REFERENCE ONLY.

THE INFORMATION CONTAINED IN THIS DRAWING IS THE SOLE PROPERTY OF INFINITE ELECTRONICS, INC. ANY REPRODUCTION IN PART OR WHOLE WITHOUT THE WRITTEN PERMISSION OF INFINITE ELECTRONICS, INC. IS PROHIBITED. THESE COMMODITIES, TECHNOLOGY OR SOFTWARE WERE EXPORTED FROM THE UNITED STATES IN ACCORDANCE WITH THE EXPORT ADMINISTRATION REGULATIONS. DIVISION CONTRARY TO U.S. LAW PROHIBITED.

ZONE	REV.	DESCRIPTION	DATE	CHANGED BY	APPROVED BY
	A	INITIAL RELEASE	02/07/2023	DMAY	TGALLA

REVISION	
1	

Fairview Microwave
an INFINIT[®] brand

Website: www.FairviewMicrowave.com
Phone: 1.800.715.4396 | 1.972.649.6678

UNLESS OTHERWISE SPECIFIED, LEADING DIMENSIONS ARE INCHES DIMENSIONS IN [] ARE MILLIMETERS

TOLERANCES:
 .X = ±.2 [5] FRACTIONS
 .XX = ±.02 [.5] ±.132
 .XXX = ±.005 [.13] ANGLES ± 1°

CABLE LENGTH TOLERANCES:
 $\le 12 [305]$ = +1 [25] / -0
 $> 12 [305]$ ≤ 60 [1524] = +2 [51] / -0
 $> 60 [1524]$ ≤ 120 [3048] = +4 [102] / -0
 $> 120 [3048]$ ≤ 300 [7620] = +6 [152] / -0
 >300 [7620] = +5% / -0

ALL DIMENSIONS ARE FOR REFERENCE ONLY AND SUBJECT TO CHANGE WITHOUT NOTICE

INTERPRET ALL DIMENSIONS AND TOLERANCES PER ASME Y14.5 SHEET

SCALE: NONE

SHEET: 1 OF 2

DESCRIPTION: SP4T, SMA, LATCHING, 18GHZ, 28VDC, D-SUB, RUGGEDIZED

SIZE	CAGE CODE	DRAWN BY	ITEM NO.	REV
A	3FKR5	DMAY	FMSW6548	A

