

**SP6T Electromechanical Relay Latching Switch,
 +COM, DC to 43 GHz, 10W, 28VDC, 2.92mm**

The FMSW6572 is a Single Pole Six Throw (SP6T) electromechanical relay switch that operates across a wideband frequency range from DC to 43 GHz and can handle 10W of average power in a break before make condition. The 50 Ohm design supports a positive common (+COM) biasing configuration and features a Latching Actuator with a 2 million lifecycle rating. The Latching Actuator magnetically latches in place after the control voltage is removed. For power sensitive applications, this is the best actuator option. Impressive typical performance includes 0.7 dB insertion loss and isolation greater than 80 dB. This switch requires 28 Vdc bias voltage and operates over a temperature range of -25°C to +65°C. The rugged and compact package assembly supports 2.92mm female connectors and a 15 Pin D-SUB Connector for DC control. And for highly reliable operation, the model is guaranteed to meet MIL-STD-202 environmental test conditions for sh[°]ck and random vibration.

Electrical Specifications (TA = +25°C, DC Voltage = 28 Vdc)

Switch Type SP6T
 Actuator Type Latching

Description	Min	Typ	Max	Units
Frequency Range	DC		43	GHz
Operating Voltage	26	28	28	Volts
Actuating Current @ 28 Volts		110		mA
Actuating Reset Current		660		mA
VSWR		1.7:1	2.1:1	
Insertion Loss		0.7	1.6	dB
Isolation	40	80		dB
Switching Time		20		ms

Performance by Frequency

Description	F1	F2	F3	F4	F5	Units
Frequency Range	DC - 6	6 - 12	12 - 18	18 - 26.5	26.5 - 32	GHz
VSWR, Max	1.15:1	1.25:1	1.35:1	1.5:1	1.7:1	
Insertion Loss, Max	0.2	0.3	0.6	0.8	0.8	dB
Isolation, Min	80	75	70	70	60	dB

Performance by Frequency

Description	F6	F7	F8	F9	F10	Units
Frequency Range	32 - 40	40 - 43				GHz
VSWR, Max	1.8:12.1:1					
Insertion Loss, Max	1.1	1.6				dB
Isolation, Min	60	40				dB

Features:

- Single Pole Six Throw (SP6T) Electromechanical Relay Switch
- DC to 43 GHz Frequency Range
- Latching Actuator
- Positive Common (+COM) Configuration
- 2M Lifecycle Rating
- Insertion Loss 0.7 dB typ
- Isolation > 80 dB typ
- VSWR as low as 1.15:1 max
- 15 PIN D-SUB Connector for DC Control
- 28 Volt DC Bias
- 2.92mm Female Connectors
- -25°C to +65°C Operating Temperature
- 10 Watt Average Power Handling
- 50 Ohm Design
- Hot Switching Capability - Consult Factory
- S-Parameter Data available upon request
- Rugged Design meets Mil-STD-202 Test Conditions
- Actuating Set / Reset Feature

Applications:

- Aerospace & Defense
- Test & Measurement
- Microwave Radio Systems
- Military & Commercial Communication Systems
- Research & Development
- SATCOM
- Wireless Communications
- Enterprise
- IoT

Fairview Microwave
 301 Leora Ln., Suite 100
 Lewisville, TX 75056
 Tel: 1-800-715-4396 / (972) 649-6678
 Fax: (972) 649-6689
www.fairviewmicrowave.com
sales@fairviewmicrowave.com

Mechanical Specifications

Size

Length	1.95 in [49.53 mm]
Width/Diameter	2.75 in [69.85 mm]
Height	0.92 in [23.37 mm]
Weight	0.184 lbs [83.46 g]

Connectors

RF Connector Type	2.92mm Female
Control Connector	D-Subminiature

Environmental Specifications

Temperature

Operating Range	-25 to +65 deg C
Storage Range	-55 to +100 deg C

Shock	MIL-STD-202 Method 213, Condition D, 500G (non oper)
Vibration	MIL-STD-202 Method 204, Condition D, 10G RMS (non oper)

Compliance Certifications (see [product page](#) for current document)

Plotted and Other Data

Notes:

Typical Performance Data

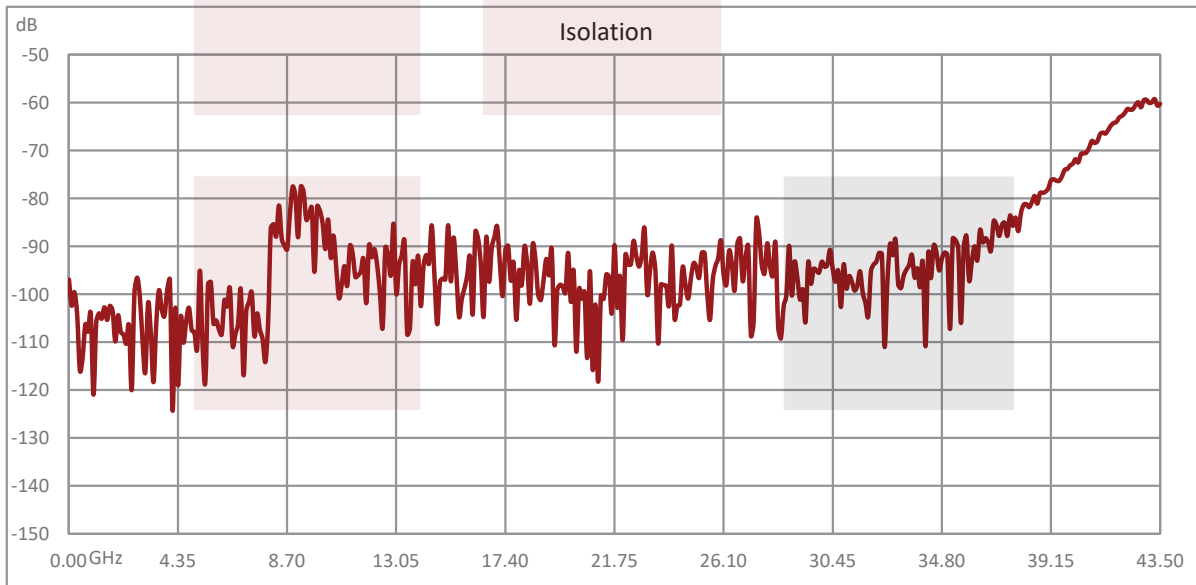

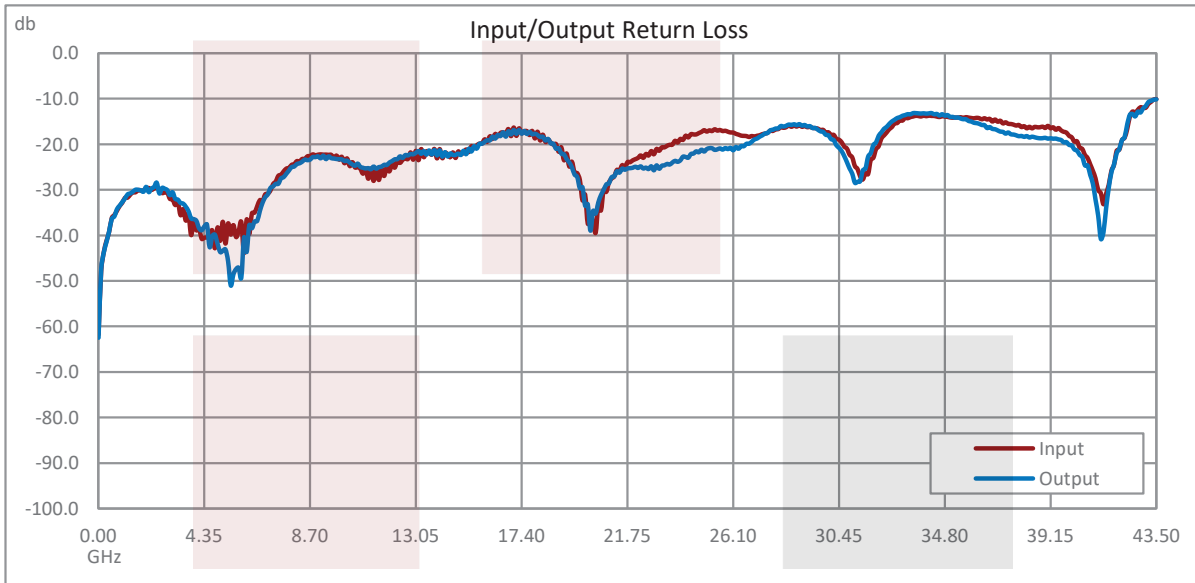
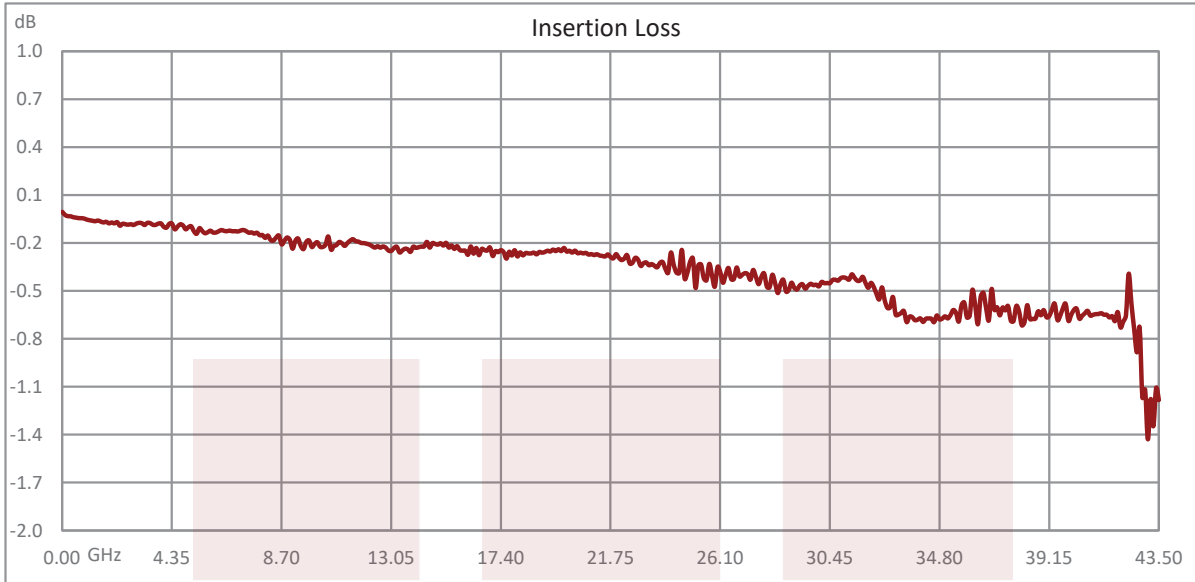

Power Handling vs. Frequency

Power Handling vs. Frequency

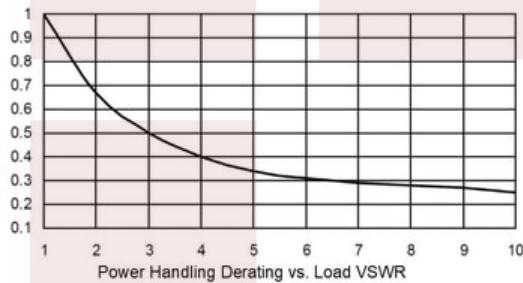
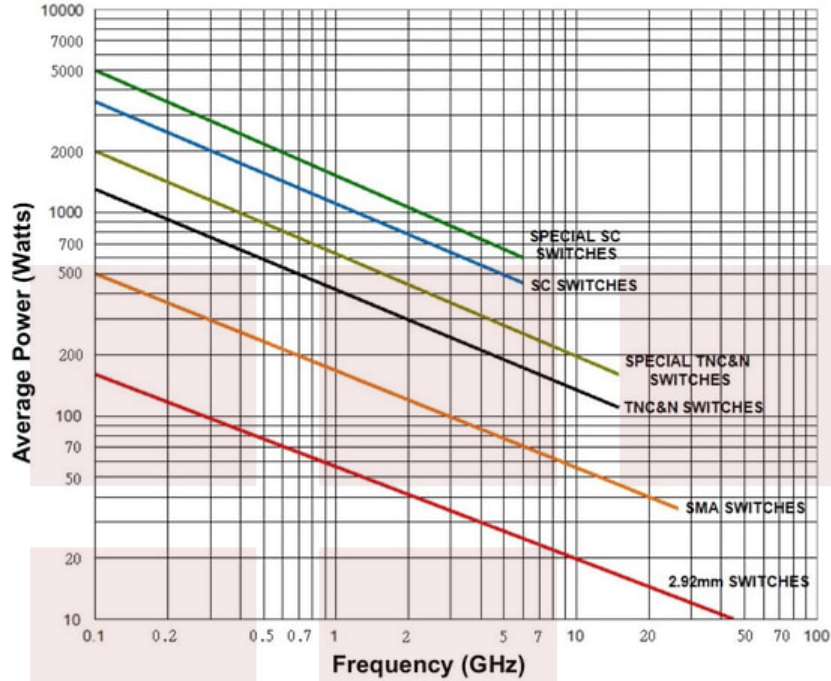

Power handling chart and derating curves based on the following conditions:

- Ambient temperature: 40°C or less
- Altitude: Sea level
- Load VSWR: 1.20:1 Maximum
- Relative Humidity: 40-50%
- Cold switching: RF signal off

Note: specifications subject to change without notice

SP6T Electromechanical Relay Latching Switch, +COM, DC to 43 GHz, 10W, 28VDC, 2.92mm from Fairview Microwave is in-stock and available to ship same-day. All of our RF/microwave products are available off-the-shelf from our ISO 9001:2008 certified facilities in Lewisville, Texas. Fairview Microwave is RF on-demand.

For additional information on this product, please click the following link: [SP6T Electromechanical Relay Latching Switch, +COM, DC to 43 GHz, 10W, 28VDC, 2.92mm FMSW6572](#)

URL: <https://www.fairviewmicrowave.com/sp6t-latching-43-ghz-electro-mechanical-relay-switch-28v-2.92mm-fm-sw6572-p.aspx>

The information contained in this document is accurate to the best of our knowledge and representative of the part described herein. It may be necessary to make modifications to the part and/or the documentation of the part, in order to implement improvements. Fairview Microwave reserves the right to make such changes as required. Unless otherwise stated, all specifications are nominal. Fairview Microwave does not make any representation or warranty regarding the suitability of the part described herein for any particular purpose, and Fairview Microwave does not assume any liability arising out of the use of any part or documentation.



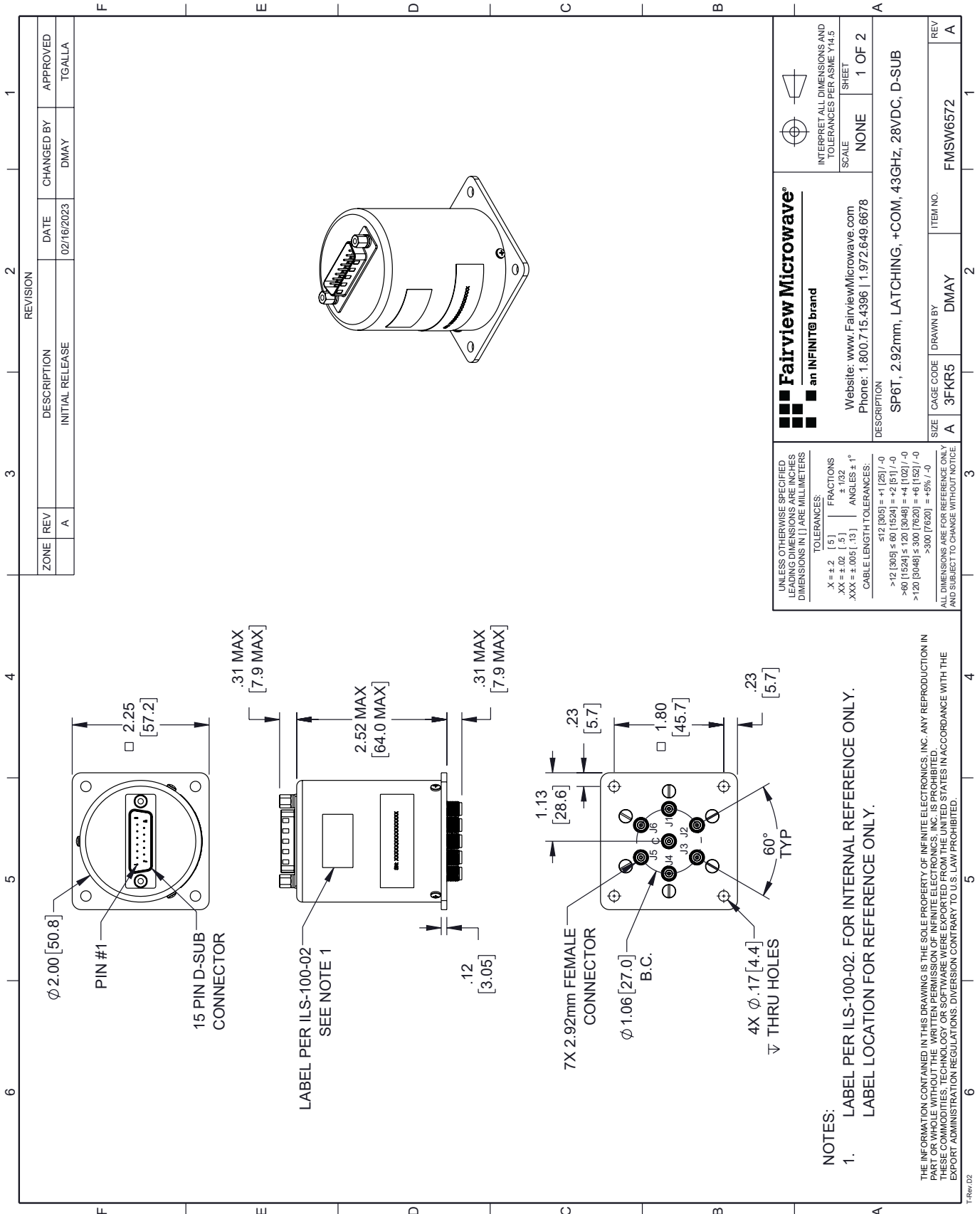

ZONE	REV	DESCRIPTION	DATE	CHANGED BY	APPROVED
	A	INITIAL RELEASE	02/16/2023	DMAY	TGALLA

REVISION	DESCRIPTION
1	INITIAL RELEASE

<p>Fairview Microwave an INFINIT[®] brand</p> <p>Website: www.FairviewMicrowave.com Phone: 1.800.715.4396 1.972.649.6678</p>	<p>INTERPRET ALL DIMENSIONS AND TOLERANCES PER ASME Y14.5 SHEET</p> <p>SCALE: NONE</p> <p>SHEET: 1 OF 2</p>
	<p>DESCRIPTION: SP6T, 2.92mm, LATCHING, +COM, 43GHZ, 28VDC, D-SUB</p>
<p>UNLESS OTHERWISE SPECIFIED LEADING DIMENSIONS ARE INCHES DIMENSIONS IN [] ARE MILLIMETERS</p> <p>TOLERANCES:</p> <p>.X = ±.2 [5] FRACTIONS .XX = ±.02 [.5] ±.132 .XXX = ±.005 [.13] ANGLES ± 1°</p> <p>CABLE LENGTH TOLERANCES:</p> <p>≤12 [305] = ±1 [25] / -0 >12 [305] ≤ 60 [1524] = +2 [51] / -0 >60 [1524] ≤ 120 [3048] = +4 [102] / -0 >120 [3048] ≤ 300 [7620] = +6 [152] / -0 >300 [7620] = +5% / -0</p> <p>ALL DIMENSIONS ARE FOR REFERENCE ONLY AND SUBJECT TO CHANGE WITHOUT NOTICE</p>	<p>ITEM NO. FMSW6572</p> <p>REV A</p>

NOTES:

- LABEL PER ILS-100-02. FOR INTERNAL REFERENCE ONLY.
LABEL LOCATION FOR REFERENCE ONLY.

THE INFORMATION CONTAINED IN THIS DRAWING IS THE SOLE PROPERTY OF INFINITE ELECTRONICS, INC. ANY REPRODUCTION IN PART OR WHOLE WITHOUT THE WRITTEN PERMISSION OF INFINITE ELECTRONICS, INC. IS PROHIBITED. THESE COMMODITIES, TECHNOLOGY OR SOFTWARE WERE EXPORTED FROM THE UNITED STATES IN ACCORDANCE WITH THE EXPORT ADMINISTRATION REGULATIONS. DIVERSION CONTRARY TO U.S. LAW PROHIBITED.

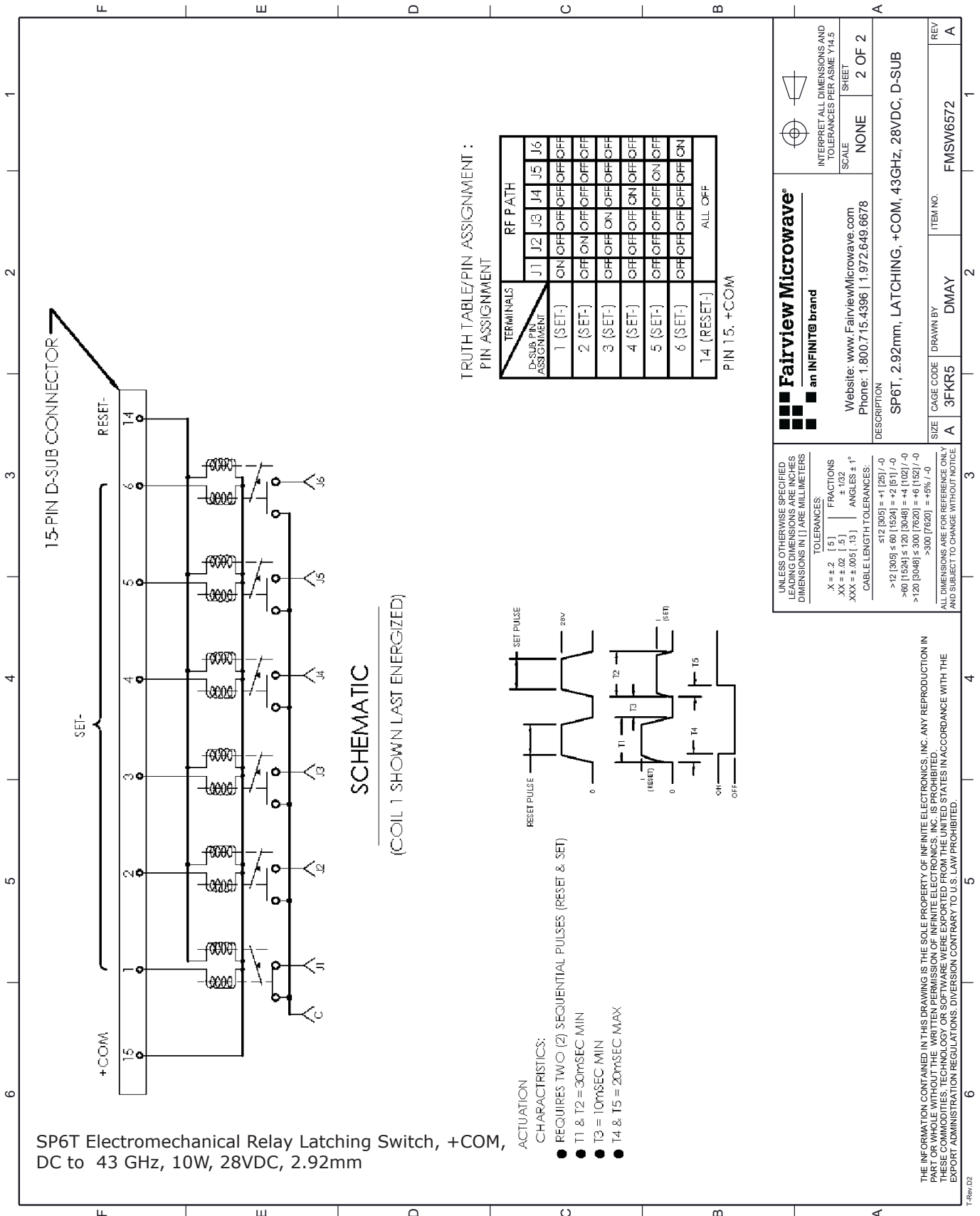

SP6T Electromechanical Relay Latching Switch, +COM, DC to 43 GHz, 10W, 28VDC, 2.92mm

Fairview Microwave
an INFINIT[®] brand

Website: www.FairviewMicrowave.com
Phone: 1.800.715.4396 | 1.972.649.6678

INTERPRET ALL DIMENSIONS AND TOLERANCES PER ASME Y14.5 SHEET 2 OF 2

SCALE NONE

DESCRIPTION
SP6T, 2.92mm, LATCHING, +COM, 43GHz, 28VDC, D-SUB

UNLESS OTHERWISE SPECIFIED, LEADING DIMENSIONS ARE INCHES AND DIMENSIONS IN [] ARE MILLIMETERS

TOLERANCES:
 .X ± .2 [.5] FRACTIONS
 .XX ± .02 [.5] ANGLES ± 1°
 .XXX ± .005 [.13]
 CABLE LENGTH TOLERANCES:
 512 (205) = +1 (25) / -0
 >12 (305) ≤ 60 (1524) = +2 (51) / -0
 >60 (1524) ≤ 120 (3048) = +4 (102) / -0
 >120 (3048) ≤ 300 (7620) = +6 (152) / -0
 >300 (7620) = +5% / -0

ALL DIMENSIONS ARE FOR REFERENCE ONLY AND SUBJECT TO CHANGE WITHOUT NOTICE

ITEM NO. FMSW6572

REV A

301 Leora Ln., Suite 100, Lewisville, TX 75056 | Tel: 1-800-715-4396 / (972) 649-6678 / Fax: (972) 649-6689

Copyright © 2020 REV 1 Page 7 of 7