

## WR-187 Standard Gain Horn with 15 dBi gain, SMA Female connector

The FMWAN187-15SF standard gain horn antenna (also known as waveguide horn) from Fairview Microwave is part of our comprehensive selection of waveguide antennas. This standard gain horn is mated with a WR-187 to SMA Female waveguide to coaxial adapter and operates from 3.95 GHz to 5.85 GHz.

Our FMWAN187-15SF standard gain horn antenna has a nominal gain of 15 dBi with a Horizontal and Vertical HPBW (Half Power Beam Width) of 31 dB and 32 dB respectively. Fairview Microwave's SMA Female to WR-187 standard gain horns are available in 10, 15 and 20 dBi models with pyramidal shape and connectorized input.

Waveguide antennas, such as the FMWAN187-15SF are used in a wide variety of applications due to the high-power handling capability, low loss, high directivity, and near constant electrical performance. Our WR-187 waveguide antennas with SMA Female interface is part of over 40,000 RF, microwave and millimeter wave components from Fairview Microwave available worldwide and Ship same day.

### Configuration

Design WR-187 Standard Gain Horn  
Coaxial Interface SMA Female

### Electrical Specifications

Description	Min	Typ	Max	Units
Frequency Range	3.95		5.85	GHz
<b>Waveguide Standard Gain Horn</b>				
Gain		15		dBi
Horizontal 3dB Beam Width		31		Degrees
Vertical 3dB Beam Width		32		Degrees
<b>Waveguide to Coaxial Adapter</b>				
Input VSWR			1.3:1	

### Mechanical Specifications

**Size**  
Length 8.198 in 208.23 mm  
Width/Diameter 5.073 in 128.85 mm  
Height 3.65 in 92.71 mm  
Weight 0.9519 lbs 431.77 g

**RF Connector**  
Type SMA Female

**Waveguide Interface**  
Waveguide Size WR-187

### Environmental Specifications

**Compliance Certifications** (see [product page](#) for current document)

### Plotted and Other Data

Notes:



### Features:

- 3.95 GHz to 5.85 GHz
- WR-187 Waveguide Band
- 15 dBi Nominal Gain
- SMA Female Connector

### Applications:

- Antenna Measurements
- Wireless Communication
- Laboratory Use
- Microwave Radio Systems
- Radome Testing
- Automotive Antenna Test Solutions
- Radar Cross Section
- Satellite Antenna Testing

Fairview Microwave  
301 Leora Ln., Suite 100  
Lewisville, TX 75056  
Tel: 1-800-715-4396 / (972) 649-6678  
Fax: (972) 649-6689  
[www.fairviewmicrowave.com](http://www.fairviewmicrowave.com)  
[sales@fairviewmicrowave.com](mailto:sales@fairviewmicrowave.com)

**Typical Performance Data**

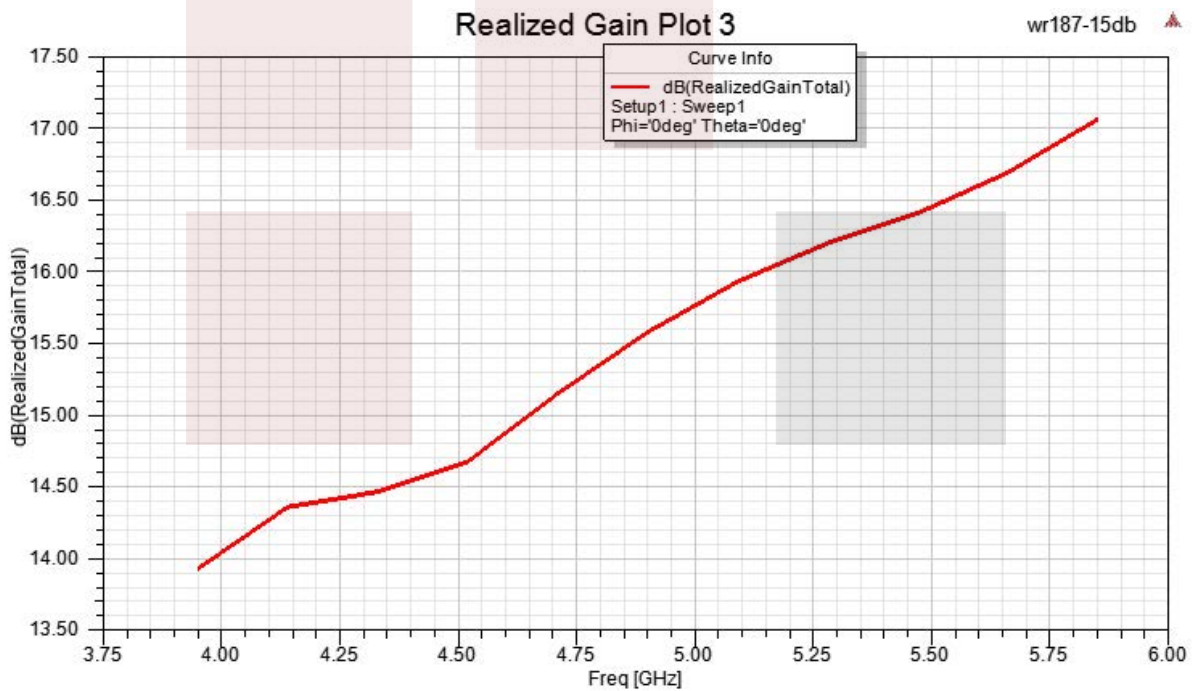
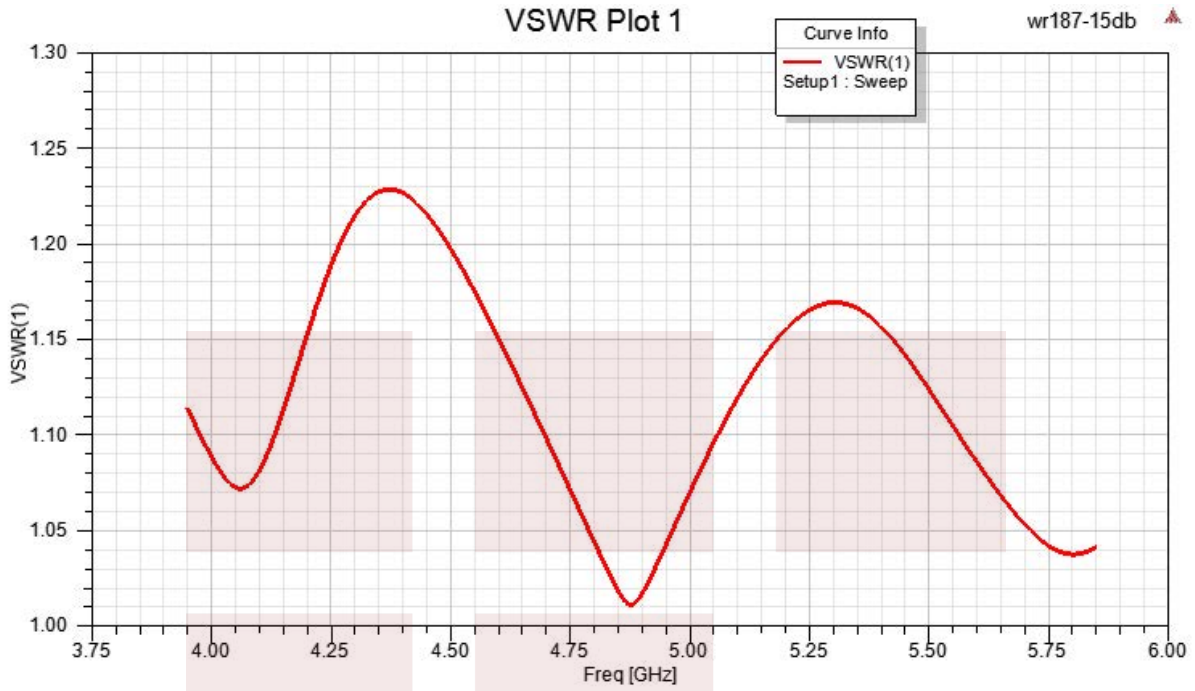

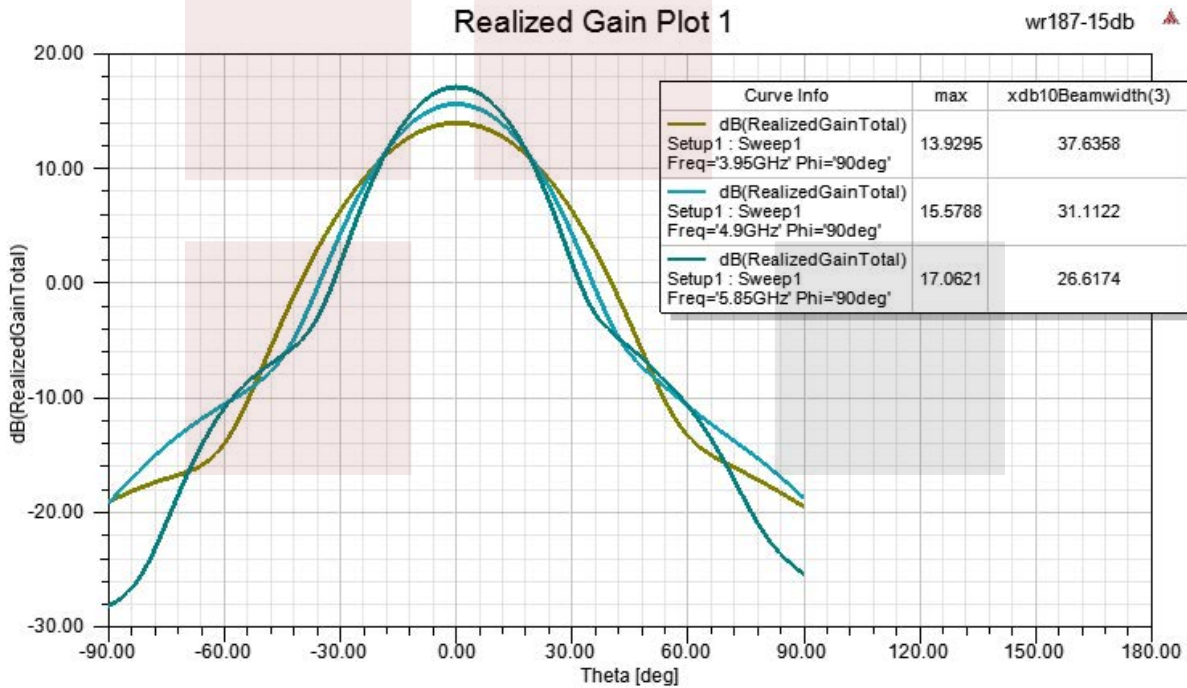
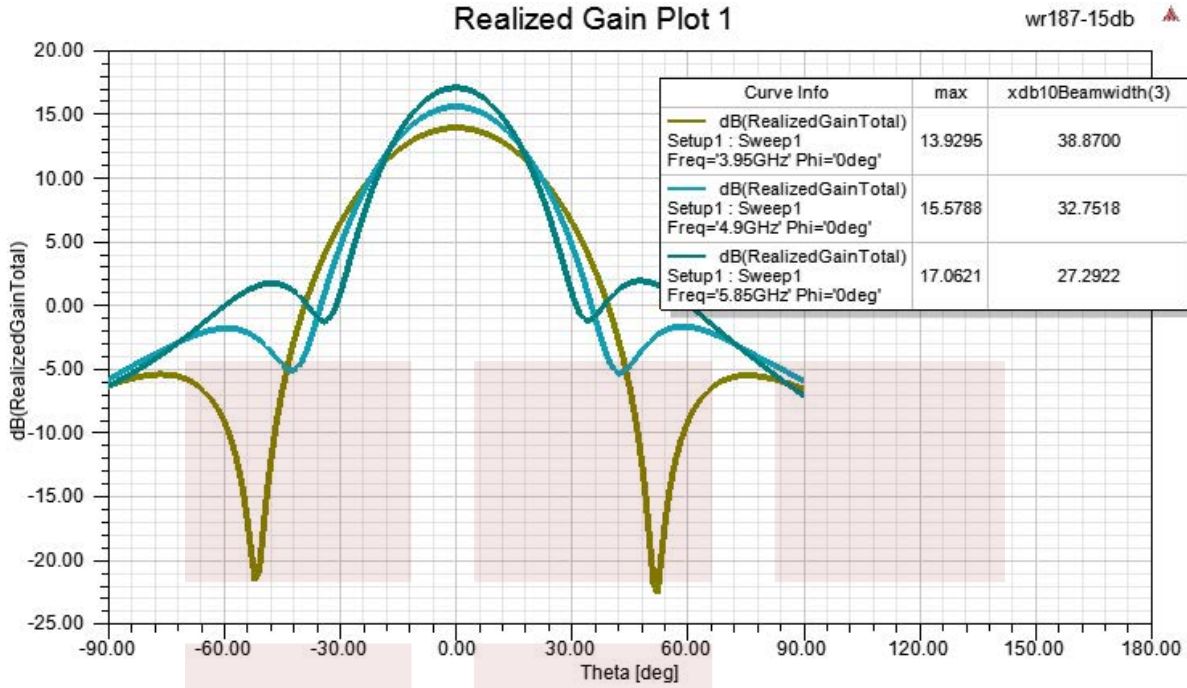

WR-187 Standard Gain Horn with 15 dBi gain, SMA Female connector from Fairview Microwave is in-stock and available to ship same-day. All of our RF/microwave products are available off-the-shelf from our ISO 9001:2008 certified facilities in Lewisville, Texas. Fairview Microwave is RF on-demand.

For additional information on this product, please click the following link: [WR-187 Standard Gain Horn with 15 dBi gain, SMA Female connector FMWAN187-15SF](#)

URL:

The information contained in this document is accurate to the best of our knowledge and representative of the part described herein. It may be necessary to make modifications to the part and/or the documentation of the part, in order to implement improvements. Fairview Microwave reserves the right to make such changes as required. Unless otherwise stated, all specifications are nominal. Fairview Microwave does not make any representation or warranty regarding the suitability of the part described herein for any particular purpose, and Fairview Microwave does not assume any liability arising out of the use of any part or documentation.



REVISIONS			
REV.	DESCRIPTION	DATE	APPROVED
A	INITIAL RELEASE	10/04/2021	KHIETPAS

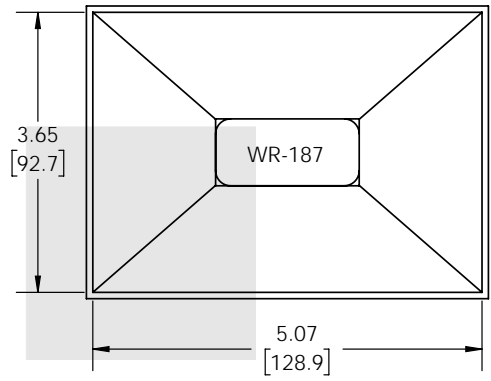
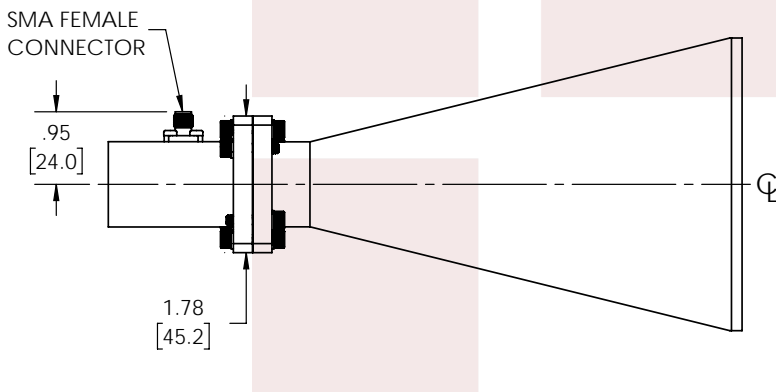
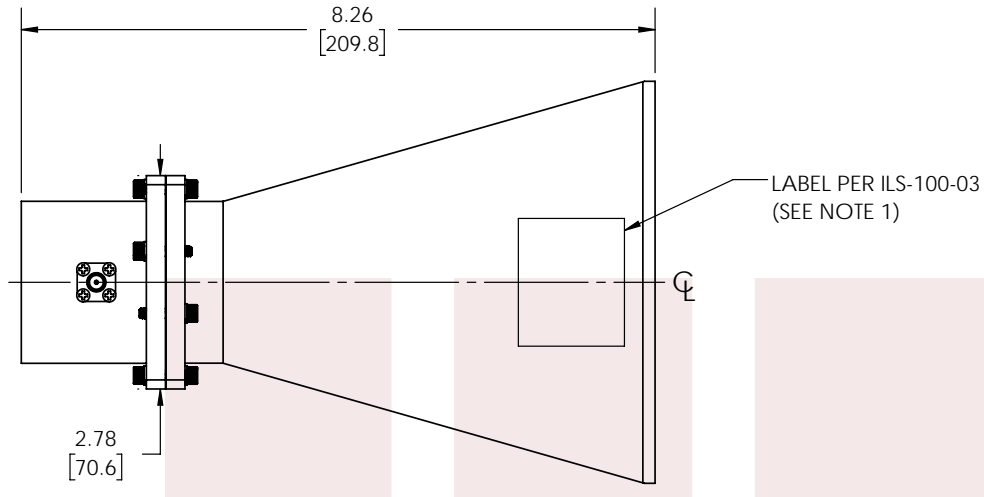

**NOTES:**

1. LABEL PER ILS-100-03 (FOR INTERNAL REFERENCE ONLY)  
LABEL LOCATION FOR REFERENCE ONLY

THESE COMMODITIES, TECHNOLOGY OR SOFTWARE WERE EXPORTED FROM THE UNITED STATES IN ACCORDANCE WITH THE EXPORT ADMINISTRATION REGULATIONS. DIVERSION CONTRARY TO U.S. LAW PROHIBITED.

TITLE

WR-187 Standard Gain Horn with 15 dBi gain, SMA Female connector

UNLESS OTHERWISE SPECIFIED LEADING DIMENSIONS ARE INCHES  
DIMENSIONS IN [ ] ARE MILLIMETERS

TOLERANCES:

.X = ±.2 [5.08] FRACTIONS ± 1/32  
.XX = ±.02 [.51]  
.XXX = ±.005 [.13]

CABLE LENGTH (L) TOLERANCES:

L ≤ 12 [305] = +1 [25] / -0  
12 [305] < L ≤ 60 [1524] = +2 [51] / -0  
60 [1524] < L ≤ 120 [3048] = +4 [102] / -0  
120 [3048] < L ≤ 300 [7620] = +6 [152] / -0  
300 [7620] < L = +5%L / -0

ALL DIMENSIONS SHOWN ARE FOR REFERENCE ONLY.

THIRD-ANGLE PROJECTION



THE INFORMATION AND DESIGN IN THIS DOCUMENT IS THE PROPERTY OF FAIRVIEW MICROWAVE CORPORATION. ALL RIGHTS RESERVED.

SHEET 1 OF 1

SCALE N/A

SIZE A	CAGE CODE 3FKR5	DRAWN BY BPUCHASKI	ITEM NO. FMWAN187-15SF	REV A
-----------	--------------------	-----------------------	---------------------------	----------

T-Rev.D