

**30 dB Waveguide Fixed Attenuator, WR-10 with UG-387/U-Mod Cover Flange, Max Power 1W**

FMWAT1012-30 is a WR-10 waveguide attenuator with 30 dB attenuation, operating in the 75 to 110 GHz frequency range. With typical VSWR performance of 1.15:1, the attenuator uses an UG-387/U-Mod cover flange that is made of gold plated aluminum. Fairview Microwave offers standard mid-band tuned Waveguide fixed attenuators with attenuation values from 3 to 30 dB. In addition to waveguide fixed attenuator product line, Fairview Microwave also offers a wide range of waveguide products which are available in stock and ready for same-day shipment.



**Electrical Specifications**

Description	Min	Typ	Max	Units
Frequency Range	75		110	GHz
Attenuation		30		dB
VSWR		1.15:1		
Input Power (Peak)			1	Watt

**Mechanical Specifications**

Size	
Length	2 in [50.8 mm]
Width	0.1 in [2.54 mm]

Description	Flange 1	Waveguide	Flange 2
Interface	UG-387/U-Mod	WR-10	UG-387/U-Mod
Material	Aluminum	Aluminum	Aluminum
Plating	Gold	Gold	Gold

**Features:**

- WR-10 Waveguide
- Typical attenuation level: 30 dB
- Operating Frequency Range from 75 GHz to 110 GHz
- UG-387/U-Mod cover Flanges
- 1.15:1 Typ. VSWR
- 1.0 Watts (CW) Max Power Handling.

**Applications:**

- Instrumentation
- Research and development
- System calibration
- Test benches

Fairview Microwave  
301 Leora Ln., Suite 100  
Lewisville, TX 75056  
Tel: 1-800-715-4396 / (972) 649-6678  
Fax: (972) 649-6689  
[www.fairviewmicrowave.com](http://www.fairviewmicrowave.com)  
[sales@fairviewmicrowave.com](mailto:sales@fairviewmicrowave.com)

**Compliance Certifications** (see [product page](#) for current document)

**Plotted and Other Data**

Notes:

30 dB Waveguide Fixed Attenuator, WR-10 with UG-387/U-Mod Cover Flange, Max Power 1W from Fairview Microwave is in-stock and available to ship same-day. All of our RF/microwave products are available off-the-shelf from our ISO 9001:2008 certified facilities in Lewisville, Texas. Fairview Microwave is RF on-demand.

For additional information on this product, please click the following link: [30 dB Waveguide Fixed Attenuator, WR-10 with UG-387/U-Mod Cover Flange, Max Power 1W FMWAT1012-30](#)

URL: <https://www.fairviewmicrowave.com/wr-10-waveguide-attenuator-fixed-110ghz-fmwat1012-30-p.aspx>

The information contained in this document is accurate to the best of our knowledge and representative of the part described herein. It may be necessary to make modifications to the part and/or the documentation of the part, in order to implement improvements. Fairview Microwave reserves the right to make such changes as required. Unless otherwise stated, all specifications are nominal. Fairview Microwave does not make any representation or warranty regarding the suitability of the part described herein for any particular purpose, and Fairview Microwave does not assume any liability arising out of the use of any part or documentation.

REVISIONS			
REV.	DESCRIPTION	DATE	APPROVED
A	INITIAL RELEASE	05-04-2021	SPONG

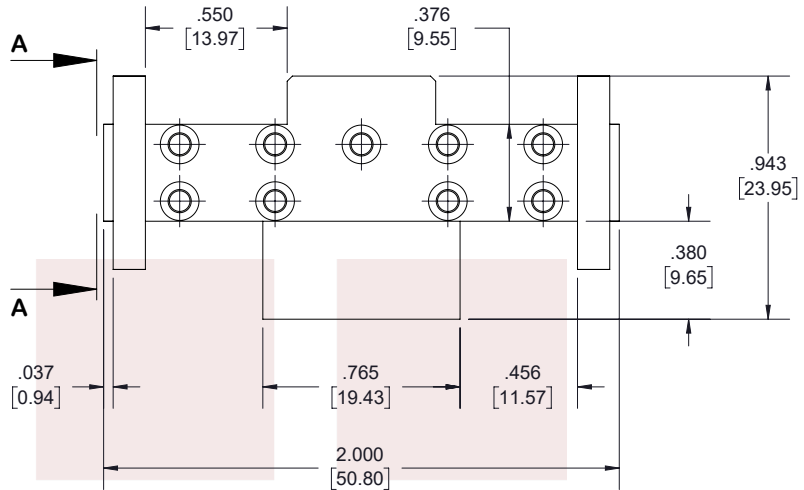
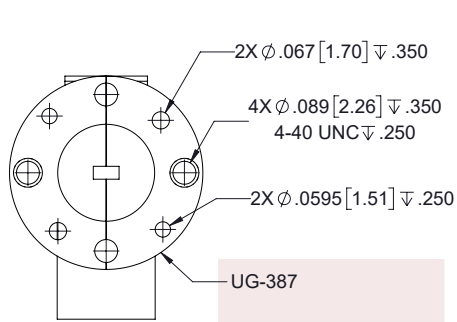

**SECTION A-A**

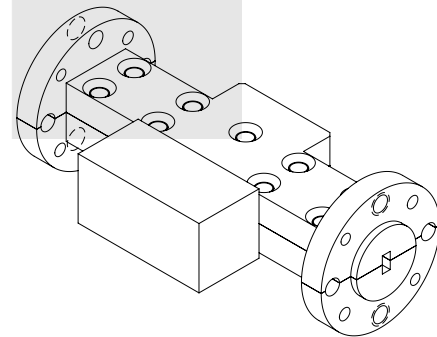
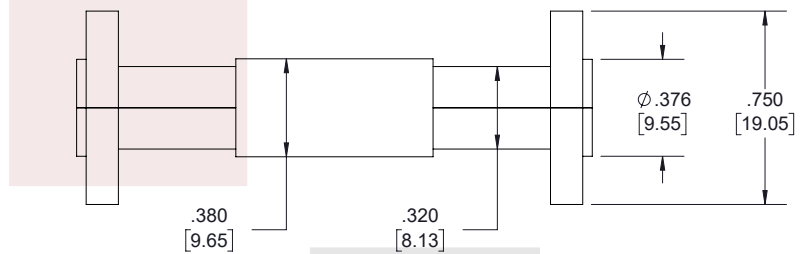
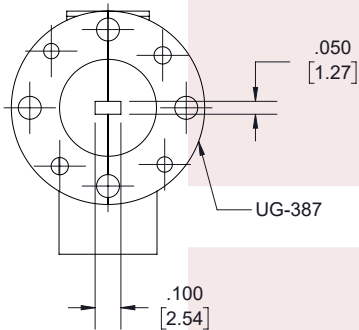

THESE COMMODITIES, TECHNOLOGY OR SOFTWARE WERE EXPORTED FROM THE UNITED STATES IN ACCORDANCE WITH THE EXPORT ADMINISTRATION REGULATIONS. DIVERSION CONTRARY TO U.S. LAW PROHIBITED.

TITLE

30 dB Waveguide Fixed Attenuator, WR-10 with UG-387/U-Mod Cover Flange, Max Power 1W

UNLESS OTHERWISE SPECIFIED LEADING DIMENSIONS ARE INCHES  
DIMENSIONS IN [ ] ARE MILLIMETERS

TOLERANCES: CABLE LENGTH (L) TOLERANCES:

.X = ±.2 [5.08] FRACTIONS ± 1/32 L ≤ 12 [305] = +1 [25] / -0  
.XX = ±.02 [51] 12 [305] < L ≤ 60 [1524] = +2 [51] / -0  
.XXX = ±.005 [13] ANGLES ± 1° 60 [1524] < L ≤ 120 [3048] = +4 [102] / -0  
120 [3048] < L ≤ 300 [7620] = +6 [152] / -0  
300 [7620] < L = +5%L / -0

THIRD-ANGLE PROJECTION



THE INFORMATION AND DESIGN IN THIS DOCUMENT IS THE PROPERTY OF FAIRVIEW MICROWAVE CORPORATION. ALL RIGHTS RESERVED.

SHEET 1 OF 1

ALL DIMENSIONS SHOWN ARE FOR REFERENCE ONLY.

SCALE N/A

SIZE A	CAGE CODE 3FKR5	DRAWN BY MVEERAPPAN	ITEM NO. FMWAT1012-XX	REV A
-----------	--------------------	------------------------	--------------------------	----------

T-Rev.D