

50 dB WR-34 Waveguide Crossguide Coupler with UG Cover Flange and 2.92mm Female Coupled Port from 21.7 GHz to 33 GHz in Brass

The FMWCP1088K-50 is a 50 dB WR-34 three port crossguide coupler with integrated 2.92mm Female connector for the coupled port. This coupler can be mounted directly into the waveguide signal path, connected via coax to allow signal sampling /monitoring. The coupler has a typical VSWR of 1.1:1 and are made of Brass with UG Cover flanges. The FMWCP1088K-50 is part of a family of cross guide couplers offered by Fairview Microwave with coupling values ranging from 20 to 50 dB.

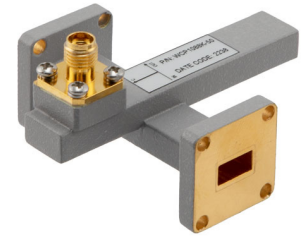

Electrical Specifications

Description	Min	Typ	Max	Units
Frequency Range	21.7		33	GHz
Coupler				
Nominal Coupling Level		50		dB
Coupling Accuracy			±1.5	dB
Directivity	15			dB
Insertion Loss		0.2		dB
Main Line VSWR			1.1:1	
Secondary Line VSWR			1.5:1	
Input Power (CW)			250	Watts
Input Power Peak			30	kWatts

Mechanical Specifications

Size	
Length	2.362 in [59.99 mm]
Width	1.969 in [50.01 mm]
Height	1.36 in [34.54 mm]
Weight	0.11 lbs [49.9 g]
Interface	
Waveguide Size	WR-34
Flange Type	UG Cover
RF Connector Type	2.92mm Female
Coupler Body Material and Plating	Brass Copper, Gold

Environmental Specifications

Compliance Certifications (see [product page](#) for current document)

Plotted and Other Data

Notes:

Features:

- Three Port Crossguide Waveguide Coupler
- 50±1.5 dB Nominal Coupling Level
- Integrated 2.92mm Female Connector for the coupled port
- 21.7 GHz to 33 GHz Frequency Range
- Low VSWR < 1.5:1"

Applications:

- Test Benches
- Radar
- Satellite
- Microwave Radio
- Attenuation Measurements
- Power Measurements
- Source Leveling

Fairview Microwave
 301 Leora Ln., Suite 100
 Lewisville, TX 75056
 Tel: 1-800-715-4396 / (972) 649-6678
 Fax: (972) 649-6689
www.fairviewmicrowave.com
sales@fairviewmicrowave.com

50 dB WR-34 Waveguide Crossguide Coupler with UG Cover Flange and 2.92mm Female Coupled Port from 21.7 GHz to 33 GHz in Brass from Fairview Microwave is in-stock and available to ship same-day. All of our RF/microwave products are available off-the-shelf from our ISO 9001:2008 certified facilities in Lewisville, Texas. Fairview Microwave is RF on-demand.

For additional information on this product, please click the following link: [50 dB WR-34 Waveguide Crossguide Coupler with UG Cover Flange and 2.92mm Female Coupled Port from 21.7 GHz to 33 GHz in Brass FMWCP1088K-50](#)

URL: <https://www.fairviewmicrowave.com/50-db-wr-34-waveguide-crossguide-coupler-fmwcp1088K-50-p.aspx>

The information contained in this document is accurate to the best of our knowledge and representative of the part described herein. It may be necessary to make modifications to the part and/or the documentation of the part, in order to implement improvements. Fairview Microwave reserves the right to make such changes as required. Unless otherwise stated, all specifications are nominal. Fairview Microwave does not make any representation or warranty regarding the suitability of the part described herein for any particular purpose, and Fairview Microwave does not assume any liability arising out of the use of any part or documentation.



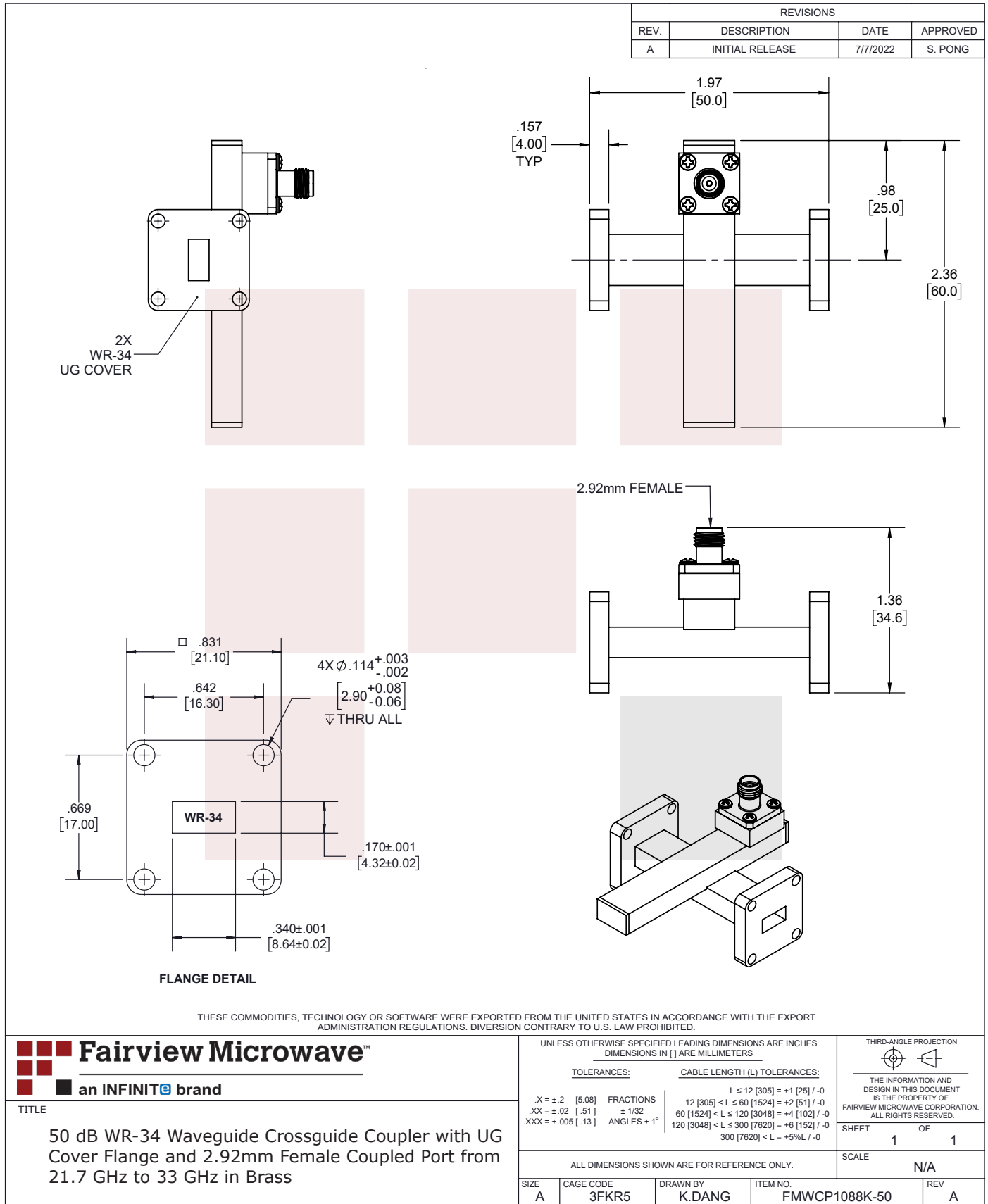

T-Rev.D